

*** CORRECTED ***



INCIDENT ACTION PLAN

OPERATIONAL PERIOD

8/31/2020 0700 - 9/1/2020 0700

Monday



PNF North Complex
CA-PNF-001308
P5 NFZ7 (0511)

PNF Sheep Incident
CA-PNF-001299
P5 NGS4 (0511)

- 0700 - Operations Briefing
- 1000 - Cooperators Zoom
- 1800 - Planning Meeting
- 1900 - Night Operations Briefing

* CORRECTED *

INCIDENT OBJECTIVES (ICS 202)

1. Incident Name: <p style="text-align: center;">NORTH COMPLEX</p>	2. Operational Period: <table style="width: 100%; border: none;"> <tr> <td style="padding: 0 10px;">Date From:</td> <td style="padding: 0 10px;">8/31/2020</td> <td style="padding: 0 10px;">Date To:</td> <td style="padding: 0 10px;">9/1/2020</td> </tr> <tr> <td style="padding: 0 10px;">Time From:</td> <td style="padding: 0 10px;">0700</td> <td style="padding: 0 10px;">Time To:</td> <td style="padding: 0 10px;">0700</td> </tr> </table>	Date From:	8/31/2020	Date To:	9/1/2020	Time From:	0700	Time To:	0700
Date From:	8/31/2020	Date To:	9/1/2020						
Time From:	0700	Time To:	0700						

3. Objective(s):

Leaders Intent: Suppress the North Complex and Sheep fires using a full range of management tactics & strategies that minimize exposure to firefighters, communities, and reduce the susceptibility to COVID19.

Management Objectives:

- Ensure safety of emergency responders & public utilizing strategies & risk management processes.
- Protect natural and cultural resources, commercial timber, and critical infrastructure while utilizing resource & agency advisors.
- Foster and maintain good relationships with local cooperators, stakeholders, and public while providing coordinated, accurate and timely information.
- Effectively manage cost by implementing strategies and tactics that have a high probability of success.

Control Objectives:

- Suppress all new fires in the complex on the Mt. Hough RD
- Keep all fires within existing perimeters

Sheep Fire - keep the fire:

- West of Richmond & Highway 395
- North of Fruit Growers Blvd
- East of Road 29N46
- South of Hwy 36

Claremont Fire - keep the fire:

- South and West of Pine Creek Valley
- East of the Minerva Trail and 1999 Pidgeon Fire burn scar
- North of Cleghorn Bar Road and Trail

Bear Fire - keep the fire:

- West of the Minerva Trail and 1999 Pidgeon Fire burn scar
- North of Middle Fork Feather River
- East of Road 23N60 and Hartman Bar Trail
- South of Roads 24N28, 23N14, and 23N16

General Situational Awareness:

Be aware of potential outflow winds from thunderstorms which may bring new life to areas that have had minimal activity.

Steep terrain and fire weakened trees create potential for rollout.

To help protect yourself, your family and to ensure all employees return home safely, make sure to practice physical distancing and wear a face covering.

Be prepared for the increase in activity in the afternoon.

Enhanced hygiene (especially handwashing), PPE & monitoring practices help limit the infection rate of first responders.

5. Site Safety Plan Required? Yes No

Approved Site Safety Plan(s) Located at:

6. Incident Action Plan

<input checked="" type="checkbox"/> ICS 203	<input checked="" type="checkbox"/> ICS 215A	<input type="checkbox"/> ICS 205 A	<input type="checkbox"/>
<input checked="" type="checkbox"/> ICS 204	<input checked="" type="checkbox"/> ICS 220	<input type="checkbox"/> Training Message	<input type="checkbox"/>
<input checked="" type="checkbox"/> ICS 205	<input type="checkbox"/> Facility Maps	<input checked="" type="checkbox"/> Travel Map	<input checked="" type="checkbox"/> Water Use Log
<input checked="" type="checkbox"/> ICS 206	<input checked="" type="checkbox"/> Weather Forecast	<input checked="" type="checkbox"/> Demob Plan	<input checked="" type="checkbox"/> County Health Message
<input checked="" type="checkbox"/> ICS 208	<input checked="" type="checkbox"/> Fire Behavior	<input checked="" type="checkbox"/> Finance Message	<input checked="" type="checkbox"/> ICS 214

7. Prepared By:	Christie Neil / Dana Carter / Derek Parker(t)	Position/Title: PSC	Signature:
8. Approved by Incident Commander:	Jerry McGowan	Signature:	

ICS 202

ORGANIZATION ASSIGNMENT LIST (ICS 203)

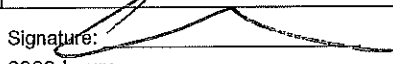
1. Incident Name: NORTH COMPLEX		2. Operational Period: Date From: 8/31/2020 Date To: 9/1/2020 Time From: 0700 Time To: 0700	
3. Incident Commander(s) and Command Staff:		7. Operation Section:	
IC/UC's	Jerry McGowan, Jim Ferguson	North Complex Ops	Chad Cook / Mario Gomez(t)
Deputy	Ken Kempter	Sheep Fire Ops	Chris Childers / Jim Topoleski / Travis Thane (t)
Safety Officer	Doug McKelvey/Charles Christensen	Claremont / Bear Night Ops	David Kelly
Information Officer	Kristen Allson / Jim Mackensen (t)	Planning Ops	Shane Santos (t)
Liaison Officer	Jacob Fuller / David Farmer (t)	Staging Area	North Complex Madeleine Levaggi
Liaison Officer	Celeste Prescott (t)	Branch	II - Claremont Peter Tolosano
4. Agency/Organization Representatives:		Division/Group	
Agency/Organization	Name	Division/Group	P Ryan Bauer
CAL FIRE - AA	Scott Packwood	Division/Group	S/V/X Chris Voelker / Shawn Woodbury(t)
USFS - PNF AA	Chris Carlton	Division/Group	
USFS - PNF AA	Barbara Drake	Division/Group	Z Trevor Johnson
USFS - PNF AREP	Dave Brillenz, Feather River RD	Branch	IV - Sheep Will Raulerson
USFS - PNF AREP	Andy Welsh, Mt. Hough RD	Division/Group	A Jason Miller
USFS - LNF AA	Deb Bumpus	Division/Group	B Jack Selvelson / Amy McClave
USFS - LNF AREP	Pete Martens / Stew Richter	Division/Group	M Jerry Horton
CHP	Erik Eglide	Branch	V - Sheep Adam Mattos
SPI	Steve Dubonis	Division/Group	D Kris Schroeder
WM Beaty & Associates	John Vann	Division/Group	F Joe Walton
OES Sheep Fire	Pat Titus	Division/Group	H Tim Williams / Jenn Corning (t)
OES North Complex	Kit Bailey	Division/Group	
		Division/Group	
		Branch	X- Bear Don Fregulia / Kerri Gilliland (t)
		Division/Group	AA Gene Neely / Chad Lauer (t)
		Division/Group	MM Patrick Callahan
5. Planning Section:		Division/Group	
Chief	Christie Neill / Dana Carter / Derek Parker (t)	Division/Group	
Deputy	Audrey French (t) - virtual	Division/Group	QQ Patrick Preston / Eric Borlaug (t)
Resource Unit	Danny Douglas / Janet Griesdal / Kelly Mosinski (t)	Division/Group	TT Richard Ingram / Clint Isbell (t)
Situation Unit	Robert Verde / Chris Auby (t)	Branch	
Demobilization Unit	Brian Dameron	Division/Group	SPG Garrett Prater / Jason Bunker (t)
GISS	Roberts / Hans / Haskell / Powell / Felker	Division/Group	IA / Patrol Jordan Townsend
FBAN	Rich McCrea / Patrick Doyle (t)	Division/Group	Night Jason Jensen / Mark Hansen (t)
IMET	Brett Lutz / Christian Cassell	Division/Group	CONTINGENCY RAY TORRES / CHRIS KING (t)
Training Tech Spec	Heather Grove (t) - virtual	Division/Group	
ITSS	Jacob Huerta / Ulysses Huerta	Air Operations Branch	Director:
Resource Advisor	Steve Hodges	Air Support Group Supervisor	Kyle Beinschroth
Human Resources	Linda Buck	Air Tactical Group Supervisor	
6. Logistics Section		Hellbase Manager	
Chief	Richard Davis		
Supply Unit	Josh Ramey	8. Finance/Administration Section:	
Facilities Unit	Doug Winn / Romaldo Navarro (t)	Chief	Pamela Meyer
Ground Support Unit	Dave Trussell	Time Unit	Rene White / Ariana Rivera (t)
Communications Unit	Kody Kerwin	PCTR	Renee Smith / Jelinek / Flannary
INCM	Scott LaRue	Comp/Claims Unit	Deborah McIntosh
Medical Unit	Brian Wisler / Kain Packwood	Cost Unit	Robert Taylor / Andrew Wheatley - virtual
ORDM / RCDM	Lori Cayo / Marty Lee / A. Espinosa	EQTR	Jodi Gover / Mary Jane Derendoff
Food Unit	Mike Oxborrow		
Prepared By: Name:	Christie Neill / Dana Carter / Derek Parker(t)	Position/Title:	PSC
ICS 203		Date/Time:	8/30/2020 2300 hours
		Signature:	



North Complex: Claremont & Bear Fires Weather Forecast



FORECAST NO: 10
UNIT: CA-PNF
SHIFT DATE: Monday, Aug 31, 2020
PREDICTION FOR: 0700 - 0700
FORECAST ISSUED: 1930 hrs. 8/30/20

Incident Meteorologist: Brett Lutz
SIGNED:
You can call, text, or e-mail obs to:
(240) 778-5297 / Brett.Lutz@noaa.gov

**...Relatively Dry This Morning with Mostly Clear Air Around the Fire Edges Into Early Afternoon...
...Enhanced Easterly Winds Tonight Into the Early Afternoon Tuesday...**

WEATHER DISCUSSION: Northeast flow this morning will sweep most of the smoke to areas southwest of the fires this morning. With moderate to poor RH recoveries and less smoke this morning expect heating and slope winds to get going late morning. Winds will be slope driven this afternoon and smoke will increase, but another push from the northwest and north is expected late afternoon into the evening. This push will strengthen Monday night into Tuesday morning pushing smoke further south and west. This is likely to lead to mostly clear conditions Tuesday morning.

Today (0700-1900):

Weather: Sunny. Not as much smoke with it primarily confined to the drainages in the morning. Smoke increasing and gradually becoming dense over and south and east of the fires in the afternoon.

High Temperatures: 77-83° Upper Slopes & Ridges, 83-92° Low-Mid Slopes & Valleys. (*Trend: Down 2F*)
Afternoon Humidity: 12-22%. (*Trend: Little-No Change*)

20 Foot Winds:

Valleys/Lower Slopes: Downslope & down drainage 5-10 mph in the morning, then becoming upslope and up 5-10 mph with gusts 10-15 mph in the afternoon.

Upper Slopes & Ridges: Northeast 5-10 mph in the morning, becoming upslope around noon, then Northwest 5-15 mph with gusts 15-20 mph in the afternoon.

(*Wind Trend: Up 5 mph early, then becoming up 5 mph and gusty in the afternoon.*)

Transport Wind: NE 7 mph early, becoming NW 12 mph in the afternoon.

LAL: 1.

Chc of Wetting Rain (> or = to 0.10"): 0%

Stability: Inversion near 6,000ft MSL until noon.

Afternoon Mixing Height: 9,700 feet AGL.

Tonight (1900-0700):

Weather: Clear with dense smoke early in the evening, clearing except down drainage west of the fires overnight.

Temperatures: Lows 46° valley bottoms to 67° ridges. (*Trend: Little Change*)

Overnight Max Humidity: Valleys: 55-75%; Ridges: 35-45%. (*Trend: Up 10% on the ridges*)

20 Foot Winds:

Lower Slopes: N 5-10 mph early evening, then downslope/valley NE 5-10 mph with gusts 10-20 mph overnight.

Upper Slopes: N 5-10 with gusts 10-15 mph early evening, then NE 10-20 mph with gusts 15-25 mph overnight.

LAL: 1

Chc of Wetting Rain (> OR = to 0.10"): 0%

Inversion: 6,000ft MSL with smoke becoming trapped below it.

2-5 Day Outlook, Tuesday-Friday: Getting hotter, with record breaking temps possible Fri thru next weekend.

Dry with wide diurnal temperature ranges, hot afternoons, and moderate to poor RH recoveries on the upper slopes and ridges. Mostly clear. Max Temps 82-99° with Min RHs 10-20%. Overnight Lows 45-65°. Max RHs: 25%-95%. Westerly winds 5-10mph G15 mph each PM, 5-10 mph drainage winds overnight. Mostly smoky.

Observations from Saturday, 8/30/20:

Red Hill Lookout (6333ft) W of Bear Fire: Temps: 62F/79F, RH: 45%, 25%, Max wind: SSW 12 mph.

Cashman (4478ft) near Quincy- Temps: 58F/89F, 59%, 12%, Max wind: WSW 14 mph.

Buck Lake Road West (3793ft) NE of Bear Fire- Temps: 46F/89F, RH: 96%, 11%, Max wind: SSW 13 mph.



Sheep Fire Weather Forecast



FORECAST NO: 4
UNIT: CA-PNF
SHIFT DATE: Monday, Aug 31, 2020
PREDICTION FOR: 0700 Mon– 0700 Tue
FORECAST ISSUED: 1930 hrs. 8/30/20

Incident Meteorologist: Christian Cassell

You can call, text, or e-mail obs to:
(240) 778-5305 / Christian.Cassell@noaa.gov

...Very Dry Conditions Through Early This Evening...

WEATHER DISCUSSION: Warm and very dry conditions will continue this morning with generally light northerly winds, with gradual improvement in humidity this evening. An increase in easterly winds is expected this evening through Tuesday morning, though it will be accompanied by moderate humidity recoveries through the overnight tonight. With north to east winds, visibility is likely to be much improved especially on the north and east side of the fire area.

Today (0700-1900):

Weather: Mostly Sunny. Not as smoky especially on the north and east side of the fire.

High Temperatures: 77-84° Upper Slopes & Ridges, 84-89° Low-Mid Slopes & Valleys. (*Trend: Down 3-4°*)
Afternoon Humidity: 9 to 18%. (*Trend: Down 5 percent.*)

20 Foot Winds:

Valleys/Lower Slopes: Light and Variable or Upslope/Upvalley 2 to 6 mph increasing to North to Northwest 5 to 10 mph late afternoon.

Upper Slopes & Ridges: North 2 to 4 mph increasing to North to Northwest 7 to 12 mph with gusts to 20 mph late afternoon.

Transport Wind: Northwest 10 to 15 mph.

LAL: 1.

Chc of Wetting Rain (> or = to 0.10"): 0%

Stability: Inversion at 1500-ft agl until noon local time.

Afternoon Mixing Height: 11,000 feet agl.

Tonight (1900-0700):

Weather: Mostly clear. Smoky conditions improving overnight due to northerly winds.

Temperatures: 48 to 55°.

Overnight Max Humidity: 40 to 70%

20 Foot Winds:

Lower Slopes: North to Northeast 6 to 10 mph with gusts to 15 mph early diminishing to East to Northeast 3 to 8 mph toward 0700.

Upper Slopes: Northwest to North 10 to 15 mph becoming East to Northeast during the evening and then East after midnight. Occasional gusts 20 to 25 mph.

Transport Winds: Northeast 10 to 15 mph.

LAL: 1

Chc of Wetting Rain (> OR = to 0.10"): 0%

Inversion: 4500-ft agl descending to 500-ft agl.

2-5 Day Outlook, Tuesday-Friday:

After cooler conditions (to near normal) Tuesday through Tuesday evening with an easterly breeze of 8 to 15 mph, a significant change towards a very hot (perhaps record-breaking), stagnant, and dry weather pattern begins Wednesday and lasts into at least this weekend. Max Temps 73-98° with Minimum RHs 12-20%. Lows 50-70°. Max RHs: 20%-60%.

FIRE BEHAVIOR FORECAST

FORECAST NUMBER: 12	TYPE OF FIRE: Wildland Fire
FIRE NAME: North Complex	OPERATIONAL PERIOD: 8/31/20 Day
DATE ISSUED: 8/30/20	TIME ISSUED: 2100
UNIT: Plumas NF	SIGNED: /s/ Patrick Doyle, FBAN-t/Rich McCrea, FBAN

INPUTS

WEATHER SUMMARY: **** See Fire Wx Forecast **** - Dry N-NW winds over next 2-days -

OUTPUTS

FIRE BEHAVIOR

GENERAL:

Overnight wind direction has switched to a N-NW flow, this is a critical fire weather situation in this geographical area. Northwest-to-Northeast winds bring higher wind speeds and gusts, down canyon winds, and usually much lower relative humidity (Rh) and night-time fuel moisture recovery rates. Heads up for fire activity to begin sooner, with higher wind speeds and coming from NW-N that has not tested the control lines.

Key Points:

- Very low fuel moistures (~90th percentile conditions) and low nighttime Rh recovery continues to make most if not all dead and down fuels available for burning.
- North Winds will increase in the afternoon, causing increased fire activity and potential spotting with to low relative humidity.
- Torching and spotting has contributed significantly to fire spread and challenged control efforts. Watch for holdover heat near control lines.

ERC 74 (no change, below 90th percentile) BI 54 (▲ up +2, below 90th percentile) Northern Sierras PSA NC07

100 HR Dead Fuel Moisture: 8% (▼ down -1, below 90th percentile)

1000 HR Dead Fuel Moisture: 8.0% (no change, at 90th percentile)

Expected ROS, FL, and PIGs below for uncontained/controlled fires, or if fire spots or slopes outside of control lines.

Rate of Spread (ROS): max 10-90 ch/hr, min ROS creeping to 1-10 ch/hr. Prob. Of Ignition (PIG): 81-88%

Flame Lengths (FL): areas in alignment expect FL 5-10+ ft., where fuels and topography are not in alignment expect FLs creeping to <1-5 ft.

SPECIFIC:

Branch IV & V: Sheep Fire – Minimal fire behavior overall, low Rh's, low dead fuel moisture recovery overnight.

Key Points:

- Div A/B/D - watch out for spotting in afternoon from NW-N winds increasing and being gusty. Increased fire activity in dead & down fuels due to low Rh and dry winds.
- Div H - little activity except in area at near top third of Diamond Mountains near Aspen Flats. Watch for spots in afternoon WSW winds and gusts.
- Div M/F - little activity, smoldering and burning up heavy fuels in the interior.

Branch II: Claremont Fire – Watch out in Div Z, today and tomorrow. Changing wind direction, windspeeds and gusts from the NW-N winds can cause fire to spread in direction that has not been a problem and increase activity in a previously quiet section of the fire or line.

Key Points:

- Watch out for NW-N winds, expect increased fire activity from low Rh's and afternoon winds increasing from the NW-N.
- Div Z - Expect increased fire activity to spread/spot south of Bray Creek, across lines between La Porte Road and of west of Harrison Flat over 23N10 road. Where upslope runs from Bray Creek can impact control efforts or firing operations on the 23N10 road.
- Div S/V/X – minimal fire activity in Div S/V and greatly reduced activity in Div X.

Branch X: Bear Fire – Fire spread has reached the Willow Creek on the SW side of Bear Fire, and crossed Mt. Ararat Creek. Downcanyon winds will be increased from NW-N wind direction will increase fire activity today. Canyon winds will funnel NW-N winds into NE winds, going downcanyon.

Key Point:

- Div QQ/TT - NW-N winds today, tonight and tomorrow will test SW of fire at Willow Creek drainage. Potentially spotting across Willow Creek, with upslope downwind alignment to test.
- Watch out for roll-out with material igniting below with uphill runs in drainage, and in afternoon spotting continues to be a significant component of fire spread (spotting distances 1/10 to 1/25 of mile). Fire will actively back, flank, and spread uphill/updrainage in most directions.

AIR OPERATIONS:

Inversion lifting in the afternoon, and potentially sooner with NW-N winds lifting the smoke out of drainages.

SAFETY

Check and make sure to have lookouts in place and clear communication, when you cannot see main fire or not in contact with anyone who can.

ASSIGNMENT LIST (ICS 204 WF)

CONTROLLED UNCLASSIFIED
INFORMATION/BASIC

1. Incident Name: NORTH COMPLEX		2. Operational Period: Date From: 08/31/20 Date To: 09/01/20 Time From: 0700 Time To: 0700				3. Branch Division II - Claremont P Page 1 of 1 Papa	
4. Operations Personnel: North Complex Ops: Chad Cook / Mario Gomez(t) Branch Director: Peter Tolosano Division/Group Supervisor: Ryan Bauer					Night Ops: David Kelly Branch Safety: Air Attack:		
5. Resources Assigned:							
Resource Identifier	ALS	LWD	Leader	Personnel	Request #	Hours	Reporting Location
CRW T1 Modoc HG-T21A		9/12	Willie Almand	20	C-46	12	Quincy
ENG6 Fenix 551		8/31	Kevin Flynn	3	E-134	12	Quincy
ENG6 Alpine 5		8/31	JJ Jiles	3	E-136	12	Quincy
ENG6 Access 11		8/31	Dominic Sexton	3	E-295	12	Quincy
DOZ2 Bushey #4		9/2	Bob Bushey	3	E-110	12	Quincy
FEL1 Statewide		9/9	James Pedagio	2	E-231	12	Quincy
SKG1 Tiger		9/10	Heath Ford	2	E-275	12	Quincy
SKD2 Wood River 5		9/10	Jeremy McFarland	2	E-359	12	Quincy
WT2 PNF 2		8/31	David Dube	2	E-280	12	Quincy
WT2 Silverstate		9/1	Chris McMurray	2	E-3	12	Quincy
WT1 Northstate <i>NOSHOW</i>		9/10	Turk Munk	1	E-96	12	Quincy
WT Precision 42		9/12	Mike Dainauskus	1	E-377	12	Quincy
FALM Underdog 3		9/5	Richard Brown	2	O-317	12	Quincy
TFLD(t) Wachholz		9/6	Michael Wachholz	1	O-147	12	Quincy
HEQB Hanson		9/9	Joel Hanson	1	O-370	12	Quincy
SOFR Hogge		8/31	Barry Hogge	1	O-354	12	Quincy
SOFR(t) Ray		9/2	David Ray	1	O-455	12	Quincy
REMS 1 Wilderness Medics		9/10	Ben Steele	4	E-249	12	Quincy
SOFR Hogge		8/31	Barry Hogge	1	O-354	12	Quincy
SOFR(t) Ray		9/2	David Ray	1	O-455	12	Quincy
6. Work Assignments: Continue to prep control lines from DP41 to branch IIX break. <i>ENG4 HEAT SEEKERS 9/13 NATHAN MACEK E-401</i> Prepare to conduct strategic firing operations from DP41 to branch IIX break. <i>ENG6 TORRES E-532</i> Continue holding dozer line from DP41 to Claremont Trail to secure the fire edge. <i>ENG6 PACIFIC COAST AARON ABEL E-530</i> <i>ENG6 DRAKEFORD 4 ADHAM ROWLEY E-531</i> All tactical and/or strategic firing operations must have approval from Operations.							
7. Special Instructions: Backhaul all trash, modules need to take all trash back to ICP. <i>TFLD STUCK!</i> Ambulance Medic 2 @ DP57 assigned to DIV P available branch wide. REMS 1 assigned to DIV P @ DP42 and REMS 2 assigned to DIV TT @ DP88, both are available incident wide Avoidance Flagging: North Complex will be red and black candy striped: Sheep Fire will be red and white candy stripe.							
8. Communications							
Name	Ch	Function	Rx Freq	Rx Tone	Tx Freq	Tx Tone	Notes
NIFC C10	1	COMMAND	170.4125	T10 - 107.2	165.9625	T10 - 107.2	Claremont Peak
NIFC T3	6	TACTICAL	168.6000	107.2 (T10)	168.6000	107.2 (T10)	
NORTH COMPLEX A/G CMD	13	A/G CMD	167.9500	None	167.9500	None	
NORTH COMPLEX A/G TAC	14	A/G TAC	168.4000	None	168.4000	None	
CALCORD	15	Medical	156.0750	156.7 (T6)	156.0750	156.7 (T6)	
AIR GUARD	16	Emergency	168.6250	None	168.6250	110.9 (T1)	
9. Prepared by: Name:		Danny Douglas / Kelly Mosinski(t)		RESL		Signature: <i>[Signature]</i>	
ICS 204		Date/Time: 8/30/2020 2200		Personnel Count: 55			

ASSIGNMENT LIST (ICS 204 WF)

CONTROLLED UNCLASSIFIED
INFORMATION//BASIC

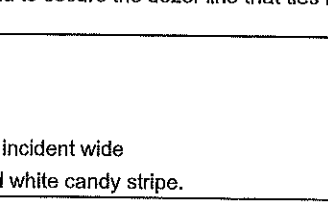
1. Incident Name: NORTH COMPLEX		2. Operational Period: Date From: 08/31/20 Date To: 09/01/20 Time From: 0700 Time To: 0700		3. Branch II - Claremont		Division S/V/X	
4. Operations Personnel: North Complex Ops: Chad Cook / Mario Gomez(t) Branch Director: Peter Tolosano Division/Group Supervisor: Chris Voelker / Shawn Woodbury(t)				Night Ops: David Kelly Branch Safety: Air Attack:			
5. Resources Assigned:							
Resource Identifier	ALS	LWD	Leader	Personnel	Request #	Hours	Reporting Location
ENG3 Wildfire Support 516		9/8	Vladimir Emil	3	E-175	12	Quincy
ENG3 Vulcan 22		9/14	Adam Tieman	3	E-177	12	Quincy
ENG3 Tristate 2		8/31	Chip Froberg	5	E-235	12	Quincy
ENG3 Cougar Fire		9/3	Cathy Reilly	3	E-285	12	Quincy
ENG3 Oftedahl Logging		9/3	Leonard Oftedahl	3	E-286	12	Quincy
ENG3 Quick Response		9/4	Darren Pickering	3	E-317	12	Quincy
ENG3 Montana Fire		9/4	Christopher Carswell	3	E-318	12	Quincy
ENG3 Cahoon 542		9/3	Joseph Meyer	3	E-322	12	Quincy
ENG4 Austin Fire		9/6	David Austin	3	E-129	12	Quincy
ENG4 Inbound 2		8/31	Amanda Douglass	3	E-178	12	Quincy
ENG4 HB Forestry 15		9/6	Mike Misek	3	E-194	12	Quincy
ENG6 Lava Beds 675		9/4	Aaron Roggenkamp	5	E-131	12	Quincy
SKG Pitman Resources			Matt Pitman	2	E-185	12	Quincy
SKG Zeb's Tree		9/11	Chris Hacker	3	E-273	12	Quincy
SKG Delaney		9/12	Blake Delaney	2	E-427	12	Quincy
SKG1 Soft Track 182		9/7	Detwiler / Guthrie	2	E-182	12	Quincy
WT1 WT 6240		9/13	Steven Billingsley	2	E-138	12	Quincy
WT1 WT 5216		9/6	Lucas Kwoka	2	E-139	12	Quincy
6. Work Assignments: Mop up around structures, dozer and handline securing the fires edge to prevent fire spread and spot fires. continue holding existing line from repeater site to DIV S/V/X / DIV Z break. Mop up and secure burn areas around structures to prevent ignition to the degree possible. Continue holding and mopping up along Hwy 70, dozer lines and the 23N22 Rd. Continue to conduct strategic firing operations to clean up the unburned fuel near Estray Creek, and to secure the dozer line that ties into Middle Fork Feather River.							
7. Special Instructions: Backhaul all trash, modules need to take all trash back to ICP. Ambulance Medic 2 @ DP57 assigned to DIV P available branch wide. REMS 1 assigned to DIV P @ DP42 and REMS 2 assigned to DIV TT @ DP88, both are available incident wide Avoidance Flagging: North Complex will be red and black candy striped; Sheep Fire will be red and white candy stripe.							
8. Communications							
Name	Ch	Function	Rx Freq	Rx Tone	Tx Freq	Tx Tone	Notes
NIFC C10	1	COMMAND	170.4125	T10 - 107.2	165.9625	T10 - 107.2	Claremont Peak
NIFC T1	5	TACTICAL	168.0500	107.2 (T10)	168.0500	107.2 (T10)	
NORTH COMPLEX A/G CMD	13	A/G CMD	167.9500	None	167.9500	None	
NORTH COMPLEX A/G TAC	14	A/G TAC	168.4000	None	168.4000	None	
CALCORD	15	Medical	156.0750	156.7 (T6)	156.0750	156.7 (T6)	
AIR GUARD	16	Emergency	168.6250	None	168.6250	110.9 (T1)	
9. Prepared by: Name:		Danny Douglas / Kelly Mosinski(t)		RESL		Signature: 	
ICS 204		Date/Time: 8/30/2020 2200		Personnel Count: 49			

ASSIGNMENT LIST (ICS 204 WF)

CONTROLLED UNCLASSIFIED
INFORMATION//BASIC

1. Incident Name: NORTH COMPLEX	2. Operational Period: Date From: 08/31/20 Date To: 09/01/20 Time From: 0700 Time To: 0700	3. Branch Division II - Claremont SVIX
--	---	--

4. Operations Personnel: North Complex Ops: Chad Cook / Marlo Gomez(t) Branch Director: Peter Tolosano Division/Group Supervisor: Chris Voelker / Shawn Woodbury(t)		Night Ops: David Kelly Branch Safety: Air Attack:
--	--	--

5. Resources Assigned:							
Resource Identifier	ALS	LWD	Leader	Personnel	Request #	Hours	Reporting Location
WT1 WT 6191		9/6	Mark Roland	2	E-140	12	Quincy
WT Allied Water		9/13	James Bantly	1	E-375	12	Quincy
WT Ryan 14		9/13	Doug Graham	1	E-489	12	Quincy
WT Basin Water		9/13	Kelth Orr	1	E-500	12	Quincy
FELB Braun		9/4	Andrew Braun	1	O-18	12	Quincy
FALM Northzone 16		9/1	Levi Brown	2	O-20	12	Quincy
FALM Timbersmith Tree Mod2		9/4	Tom Davis	2	O-193	12	Quincy
TFLD Morgan		8/31	John Morgan	1	O-192	12	Quincy
TFLD Squires		9/4	Jason Squires	1	O-215	12	Quincy
CREW 2 SES (FROM T)					C-9		
ENG 3 ADVANCED LIFE			GUTHRIE LAMBERT		E-399		
ENG 4 INBOUND			CASEY BROWN		E-533		
SKG ANLVA MILE			BEN THOMPSON		E-421		
SKG DUKES EQ.			KENNY EGGER		E-423		
WT3 BLACKHAWK			DAN THOMAS		E-493		
SOFR FULLMER (FROM Z)							

6. Work Assignments:
Mop up around structures, dozer and handline securing the fires edge to prevent fire spread and spot fires.
continue holding existing line from repeater site to DIV SVIX / DIV Z break.
Mop up and secure burn areas around structures to prevent ignition to the degree possible.
Continue holding and mopping up along Hwy 70, dozer lines and the 23N22 Rd.
Continue to conduct strategic firing operations to clean up the unburned fuel near Estray Creek, and to secure the dozer line that ties into Middle Fork Feather River.

7. Special Instructions:
Backhaul all trash, modules need to take all trash back to ICP.
Ambulance Medic 2 @ DP57 assigned to DIV P available branch wide.
REMS 1 assigned to DIV P @ DP42 and REMS 2 assigned to DIV TT @ DP88, both are available incident wide
Avoidance Flagging: North Complex will be red and black candy striped; Sheep Fire will be red and white candy stripe.

8. Communications							
Name	Ch	Function	Rx Freq	Rx Tone	Tx Freq	Tx Tone	Notes
NIFC C10	1	COMMAND	170.4125	T10 - 107.2	165.9625	T10 - 107.2	Claremont Peak
NIFC T1	5	TACTICAL	168.0500	107.2 (T10)	168.0500	107.2 (T10)	
NORTH COMPLEX A/G CMD	13	A/G CMD	167.9500	None	167.9500	None	
NORTH COMPLEX A/G TAC	14	A/G TAC	168.4000	None	168.4000	None	
CALCORD	15	Medical	156.0750	156.7 (T6)	156.0750	156.7 (T6)	
AIR GUARD	16	Emergency	168.6250	None	168.6250	110.9 (T1)	

9. Prepared by: Name:	Danny Douglas / Kelly Mosinski(t)	RESL	Signature:
ICS 204	Date/Time: 8/30/2020	2200	Personnel Count: 12

ASSIGNMENT LIST (ICS 204 WF)

CONTROLLED UNCLASSIFIED
INFORMATION/BASIC

1. Incident Name: NORTH COMPLEX		2. Operational Period: Date From: 08/31/20 Date To: 09/01/20 Time From: 0700 Time To: 0700			3. Branch Division II - Claremont Z Page 1 of 2 Zulu		
4. Operations Personnel:				North Complex Ops: Chad Cook / Mario Gomez(t) Branch Director: Peter Tolosano Division/Group Supervisor: Trevor Johnson			
				Night Ops: David Kelly Branch Safety: Air Attack:			
5. Resources Assigned:							
Resource Identifier	ALS	LWD	Leader	Personnel	Request #	Hours	Reporting Location
CRW T1 Plumas IHC		9/9	Mike Sherman	20	C-5	12	Quincy
CRW T1 Inyo IHC		9/9	Joel Schilling	20	C-36	12	Quincy
ENG3 SRF 333		9/6	Norman Goodwin	6	E-49	12	Quincy
ENG3 SRF 332		9/6	Geoffrey Phelan	6	E-50	12	Quincy
ENG3 Corns 40		9/7	Justin Corns	3	E-143	12	Quincy
ENG3 PNF 323		8/31	Tommy Brenzovich	5	E-251	12	Quincy
ENG3 Aries		9/9	Dan Martin	3	E-293	12	Quincy
ENG5 Utah 503		9/2	John Beal	3	E-350	12	Quincy
ENG6 CK Fire		8/31	Jeff Voight	3	E-137	12	Quincy
DO22 PNF 3		9/12	Shepherd/Zinn	2	E-276	12	Quincy
DO22 Traphagen 2		9/1	Torin Thompson	2	E-327	12	Quincy
DO22 Traphagen 3		9/1	Thomas Traphagen	2	E-328	12	Quincy
DO22 PNF 1		9/14	James Smith	4	E-333	12	Quincy
SKG2 Rimrock		9/6	Tyler Williams	2	E-183	24	Quincy
WT OES 41		9/8	Brian Ferry	2	E-266	12	Quincy
FELB Weir-Koetter		9/6	Christine Weir-Koetter	1	O-153	12	Quincy
FALM Underdog Timber		9/6	Craig Morgan	2	O-318	12	Quincy
FALM Homeland Services		9/5	Leaf Quinn	2	O-321	12	Quincy
6. Work Assignments:							
Prep old dozer line and road from The Cold Fire. Continue strategic firing operations on the 23N10 Rd. to middle Creek to secure fire edge. Construct indirect fireline from 23N10 road to Middle Fork Feather River. Continue containment efforts on the slop-over south of the 23N10 Rd in the Cold Fire scar.							
7. Special Instructions:							
Backhaul all trash, modules need to take all trash back to ICP. Ambulance Medic 2 @ DP57 assigned to DIV P available branch wide. REMS 1 assigned to DIV P @ DP42 and REMS 2 assigned to DIV TT @ DP88, both are available incident wide Avoidance Flagging: North Complex will be red and black candy striped: Sheep Fire will be red and white candy stripe.							
8. Communications							
Name	Ch	Function	Rx Freq	Rx Tone	Tx Freq	Tx Tone	Notes
NIFC C10	1	COMMAND	170.4125	T10 - 107.2	165.9625	T10 - 107.2	Claremont Peak
NIFC T6	8	TACTICAL	166.7750	107.2 (T10)	166.7750	107.2 (T10)	
NORTH COMPLEX A/G CMD	13	A/G CMD	167.9500	None	167.9500	None	
NORTH COMPLEX A/G TAC	14	A/G TAC	168.4000	None	168.4000	None	
CALCORD	15	Medical	156.0750	156.7 (T6)	156.0750	156.7 (T6)	
AIR GUARD	16	Emergency	168.6250	None	168.6250	110.9 (T1)	
9. Prepared by: Name:			Danny Douglas / Kelly Mosinski(t)		RESL		
					Signature: 		
ICS 204		Date/Time: 8/30/2020 2200			Personnel Count: 88		

ASSIGNMENT LIST (ICS 204 WF)

CONTROLLED UNCLASSIFIED
INFORMATION//BASIC

1. Incident Name: NORTH COMPLEX	2. Operational Period: Date From: 08/31/20 Date To: 09/01/20 Time From: 0700 Time To: 0700	3. Branch Division II - Claremont Z Page 2 of 2 Zulu
--	---	--

4. Operations Personnel: North Complex Ops: Chad Cook / Mario Gomez(t) Branch Director: Peter Tolosano Division/Group Supervisor: Trevor Johnson	Night Ops: David Kelly Branch Safety: Air Attack:
---	--

5. Resources Assigned:							
Resource Identifier	ALS	LWD	Leader	Personnel	Request #	Hours	Reporting Location
HEQB Schober		9/7	Robert Schober	1	O-164	12	Quincy
REAF (t) Brown		9/8	Seth Brown	1	O-397	12	Quincy
EMTF Boardman		9/8	Mike Boardman	1	O-350	12	Quincy
EMTF Boyd		9/11	Eric Boyd	1	O-408	12	Quincy
SOFR Fullmer → S/N/A		9/3	Don Fullmer	1	O-80	12	Quincy
S/T ENGI 0801A		9/13	MITCH BROOKHYSER	22	E-465		
ENG3 OES 8131		9/13	HERNANDEZ	4	E-544		STEVEN HERNANDEZ
S/T ENG3 4104C		9/13	CLINT CARSON	20	E-527		

6. Work Assignments:
 Prep old dozer line and road from The Cold Fire.
 Continue strategic firing operations on the 23N10 Rd. to middle Creek to secure fire edge.
 Construct indirect fireline from 23N10 road to Middle Fork Feather River.
 Continue containment efforts on the slop-over south of the 23N10 Rd in the Cold Fire scar.

7. Special Instructions:
 Backhaul all trash, modules need to take all trash back to ICP.
 Ambulance Medic 2 @ DP57 assigned to DIV P available branch wide.
 REMS 1 assigned to DIV P @ DP42 and REMS 2 assigned to DIV TT @ DP88, both are available incident wide
 Avoidance Flagging: North Complex will be red and black candy striped: Sheep Fire will be red and white candy stripe.

8. Communications							
Name	Ch	Function	Rx Freq	Rx Tone	Tx Freq	Tx Tone	Notes
NIFC C10	1	COMMAND	170.4125	T10 - 107.2	165.9625	T10 - 107.2	Claremont Peak
NIFC T6	8	TACTICAL	166.7750	107.2 (T10)	166.7750	107.2 (T10)	
NORTH COMPLEX A/G CMD	13	A/G CMD	167.9500	None	167.9500	None	
NORTH COMPLEX A/G TAC	14	A/G TAC	168.4000	None	168.4000	None	
CALCORD	15	Medical	156.0750	156.7 (T6)	156.0750	156.7 (T6)	
AIR GUARD	16	Emergency	168.6250	None	168.6250	110.9 (T1)	

9. Prepared by: Name: Danny Douglas / Kelly Mosinski(t) RESL
 Signature:
ICS 204 Date/Time: 8/30/2020 2200 Personnel Count: 5

ASSIGNMENT LIST (ICS 204 WF)

CONTROLLED UNCLASSIFIED
INFORMATION//BASIC

1. Incident Name: NORTH COMPLEX	2. Operational Period: Date From: 08/31/20 Date To: 09/01/20 Time From: 0700 Time To: 0700	3. Branch Division IV - Sheep A Page 1 of 1 Alpha
--	---	--

4. Operations Personnel: Sheep Fire Ops: Chris Childers / Jim Topoleski / Travis Thane (t) Branch Director: Will Raulerson Division/Group Supervisor: Jason Miller	Night Ops: Branch Safety: Air Attack:
---	---

5. Resources Assigned:							
Resource Identifier	ALS	LWD	Leader	Personnel	Request #	Hours	Reporting Location
ENG3 LMU E 2283			Mathews	3	E-9042	24	Susanville
ENG3 NV-WID 2311		9/10	Jared Rosoff	4	E-65	12	Susanville
ENG5 TKO 22		9/7	Allen Waiker	3	E-50008	12	Susanville
ENG5 TKO 15		9/7	TJ Lewis	3	E-50009	12	Susanville
S/T DOZ2 9334L			Gary Will	9	E-50051	24	Susanville
DOZ E-7 Oilar Ag Services		9/6	Todd Hawkins James White		E-9007	12	Susanville
SKD Sierra 1			Dustin Valladon	1		12	Susanville
SKD Sierra 3			Rick Marino	1		12	Susanville
MAST Sierra 1			Wyatt Taylor	1		12	Susanville
MAST Sierra 2			John Taylor	1		12	Susanville
WT Tubit 4		9/13	Clay Weston	2		12	Susanville
FALM A & F Enterprises #7		9/10	Pafford / Jenkins	2	O-56	12	Susanville
TFLD (t) Pascucci		8/31	Luke Pascucci	1	O-237	12	Susanville
REAF Merrifield			Jesse Merrifield	1	O-224	12	Susanville
REAF Immel			Maria Immel	1	O-222	12	Susanville
EMPF Vega		9/11	Landon Vega	1	O-441	12	Susanville
EMPF Caswell		9/12	Amarisa Caswell	1	E-109	12	Susanville
SOFR Strietzel		9/4	Thomas Strietzel	1	O-86	12	Susanville
SOFR(t) Millea		9/4	Robert Millea	1	O-135	12	Susanville

6. Work Assignments:
Construct direct fireline and improve existing road and dozer lines on the SW flank of the fire to tie into the road system in DIV B to halt fire progression.
Install hoselays and mop up to secure fireline.
Doz Sierra 1

7. Special Instructions:
Backhaul all trash, modules need to take all trash back to ICP.
Ambulance Medic 1 assigned to Branch 4 @ DP17. Available Branch wide.
REMS 1 assigned to DIV P @ DP42 and REMS 2 assigned to DIV TT @ DP88. Both are available Incident wide.
Avoidance Flagging: North Complex will be red and black candy stripe. Sheep Fire will be red and white candy stripe.

8. Communications							
Name	Ch	Function	Rx Freq	Rx Tone	Tx Freq	Tx Tone	Notes
NIFC C3	1	COMMAND	170.4250	T10 - 107.2	168.0750	T10 - 107.2	THOMPSON PEAK
VFIRE 24	9	TACTICAL	154.2725	156.7 (T6)	154.2725	156.7 (T6)	
SHEEP FIRE A/G CMD	13	A/G CMD	169.1500	None	169.1500	None	
SHEEP FIRE A/G TAC	14	A/G TAC	171.1125	None	171.1125	None	
CALCORD	15	Medical	156.0750	156.7 (T6)	156.0750	156.7 (T6)	
AIR GUARD	16	Emergency	168.6250	None	168.6250	110.9 (T1)	

9. Prepared by: Name: Danny Douglas / Kelly Mosinski(t)	RESL	Signature:
ICS 204	Date/Time: 8/30/2020 2200	Personnel Count: 38

ASSIGNMENT LIST (ICS 204 WF)

CONTROLLED UNCLASSIFIED
INFORMATION/BASIC

1. Incident Name:	2. Operational Period:	3. Branch	Division
NORTH COMPLEX	Date From: 08/31/20 Date To: 09/01/20 Time From: 0700 Time To: 0700	IV - Sheep	B
4. Operations Personnel:		Page 1 of 1	Bravo

Operations Section Chief: Chris Childers / Jim Topoleski / Travis Thane (t) Branch Director: Will Raulerson <i>R&R, back 9/3</i> Division/Group Supervisor: Jack Selvelson / Amy McClave	Night Ops: Branch Safety: Air Attack:
---	---

5. Resources Assigned:								
Resource Identifier	ALS	LWD	Leader	Personnel	Request #	Hours	Reporting Location	
CRW T1 Tahoe IHC		9/8	Daniel Guerrero	20	C-3	12	Susanville	
S/T ENG3 OES 6848C		9/11	Vonsion / Chalmers	22	E-91	12	Susanville	
DOZ White Bear E-50012 <i>excess</i>		9/9	Hoy / Hawes	2	E-50012	12	Susanville	
WT2 PNF 21		9/1	Chris Rhodes	2	E-191	12	Susanville	
WT E-16 Kirack		8/30	Payer/Read	2	E-9016	24	Susanville	
WT Viewland			Dunlap/Power	2	E-9067	24	Susanville	
FALM Timber Tipper 1		9/11	Gerald Floyd	2	O-15	12	Susanville	
FALM Timber Tipper 2		9/11	Ray Schlatter	2	O-17	12	Susanville	
FALM Timbersmith	<i>8/31</i>	<i>9/1</i>	Robby Madden	2	O-21	12	Susanville	
REAF Martin			Jake Martin	1	O-361	12	Susanville	

6. Work Assignments:
Continue to mop up and improve firelines to secure the fire's edge while maintaining personnel safety.

7. Special Instructions:
 Backhaul all trash, modules need to take all trash back to ICP.
 Ambulance Medic 1 assigned to Branch 4 @ DP17. Available Branch wide.
 REMS 1 assigned to DIV P @ DP42 and REMS 2 assigned to DIV TT @ DP88. Both are available Incident wide.
 Avoidance Flagging: North Complex will be red and black candy stripe. Sheep Fire will be red and white candy stripe.

8. Communications							
Name	Ch	Function	Rx Freq	Rx Tone	Tx Freq	Tx Tone	Notes
NIFC C3	1	COMMAND	170.4250	T10 - 107.2	168.0750	T10 - 107.2	THOMPSON PEAK
VFIRE 25	10	TACTICAL	154.2875	156.7 (T6)	154.2875	156.7 (T6)	
SHEEP FIRE A/G CMD	13	A/G CMD	169.1500	None	169.1500	None	
SHEEP FIRE A/G TAC	14	A/G TAC	171.1125	None	171.1125	None	
CALCORD	15	Medical	156.0750	156.7 (T6)	156.0750	156.7 (T6)	
AIR GUARD	16	Emergency	168.6250	None	168.6250	110.9 (T1)	

9. Prepared by: Name: Danny Douglas / Kelly Mosinski(t) RESL
 Signature: *[Signature]*
ICS 204 Date/Time: 8/30/2020 2200 Personnel Count: 57

ASSIGNMENT LIST (ICS 204 WF)

CONTROLLED UNCLASSIFIED
INFORMATION/BASIC

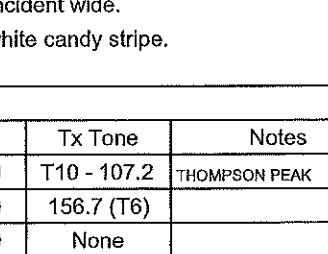
1. Incident Name: NORTH COMPLEX		2. Operational Period: Date From: 08/31/20 Date To: 09/01/20 Time From: 0700 Time To: 0700				3. Branch V - Sheep		Division D	
4. Operations Personnel:						Page 1 of 1		Delta	
Sheep Fire Ops: Chris Childers / Jim Topoleski / Travis Thane (t)					Night Ops:				
Branch Director: Adam Mattos					Branch Safety:				
Division/Group Supervisor: Kris Schroeder					Air Attack:				
5. Resources Assigned:									
Resource Identifier	ALS	LWD	Leader	Personnel	Request #	Hours	Reporting Location		
S/T ENG3-XLS-30750 DEMOS			John Evans	17	E-9021	12	Susanville		
S/T ENG3-9430G 24 hr off today		9/4	A. Cosentino	22	E-50002	12 24	Susanville		
ENG3 1927		9/2		3	E-9063	24	Susanville		
ENG5 Outback 3		9/7	Marty Lorentz	3	E-50007	12	Susanville		
ENG5 GCT		9/6	Jason Campbell	3	E-50010	12	Susanville		
ENG6 OC Forestry		9/11	Krishan Kochar	3	E-85	12	Susanville		
DOZ E-3 Simon		9/6	Justin Simon	1	E-9003	12	Susanville		
DOZ E-4 Kirack		9/6	Michael Kirak	2	E-9004	12	Susanville		
WT Susanville Towing			John Hay	1	E-9072	12	Susanville		
WT Dadco Construction			Wright/Mujar	2	E-50028	12	Susanville		
WT Lepage 66		9/6	Jim Lepage	1	E-50029	12	Susanville		
WT E-32 Darrah		9/6	Rodney Brown	1	E-50032	12	Susanville		
WT E-33 Darrah		9/6	Steve Darger	1	E-50033	12	Susanville		
SOF1 Christensen		9/2	CC Christensen	1	O-24.5	12	Susanville		
FROM H WT MCLAIN						24			
SIT 4660 C		9/8	KYLE OKERMANN	26	E-110	12			
HEQB COLBY SIMMS			COLBY SIMMS						
6. Work Assignments:									
Continue to mop up and improve firelines to secure the fire's edge while maintaining personnel safety.									
ENG 6 North Industries E-4.1									
ENG 6 Torres Contracting E-4.2									
ENG 6 Big Bear E-4.3									
7. Special Instructions:									
Backhaul all trash, modules need to take trash back to ICP.									
REMS 1 assigned to DIV P @ DP42 and REMS 2 assigned to DIV TT @ DP88. Both are available Incident wide.									
Avoidance Flagging: North Complex will be red and black candy stripe. Sheep Fire will be red and white candy stripe.									
8. Communications									
Name	Ch	Function	Rx Freq	Rx Tone	Tx Freq	Tx Tone	Notes		
NIFC C3	1	COMMAND	170.4250	T10 - 107.2	168.0750	T10 - 107.2	THOMPSON PEAK		
VFIRE 23	8	TACTICAL	154.2950	156.7 (T6)	154.2950	156.7 (T6)			
SHEEP FIRE A/G CMD	13	A/G CMD	169.1500	None	169.1500	None			
SHEEP FIRE A/G TAC	14	A/G TAC	171.1125	None	171.1125	None			
CALCORD	15	Medical	156.0750	156.7 (T6)	156.0750	156.7 (T6)			
AIR GUARD	16	Emergency	168.6250	None	168.6250	110.9 (T1)			
9. Prepared by: Name:		Danny Douglas / Kelly Mosinski(t)			RESL		Signature: 		
ICS 204		Date/Time: 8/30/2020		2200		Personnel Count: 61			

ASSIGNMENT LIST (ICS 204 WF)

CONTROLLED UNCLASSIFIED
INFORMATION//BASIC

1. Incident Name: NORTH COMPLEX	2. Operational Period: Date From: 08/31/20 Date To: 09/01/20 Time From: 0700 Time To: 0700	3. Branch Division V - Sheep F Page 1 of 1 Foxtrot
--	---	---

4. Operations Personnel: Sheep Fire Ops: Chris Childers / Jim Topoleski / Travis Thane (t) Branch Director: Adam Mattos Division/Group Supervisor: Joe Walton		Night Ops: Branch Safety: Air Attack:
--	--	---

5. Resources Assigned:							
Resource Identifier	ALS	LWD	Leader	Personnel	Request #	Hours	Reporting Location
CRW2 Antelope 3			Park	14	C-9001	12	Susanville
S/T ENG1 XMR 2126A		9/7	Kyle Hamilton	22	E-3	24	Susanville
S/T ENG1 XMR 2140C DMOB		9/6	Robert LaCroix	22	E-50049	24	Susanville
ENG3 LMU E 2289			A. Thornhill	3	E-9045	24	Susanville
ENG3 LNF 312		9/2	Shawn Miller	5	E-104	12	Susanville
ENG T/F XLS 3800	Yes	9/2	Christopher Baker	17	E-9022	12	Susanville
DOZ2 LMU D 2244			Walton / Wolter	2	E-9001	12	Susanville
DOZ E-6 UB Dozing		9/1	Dillion Boggs	2	E-9006	12	Susanville
DOZ E-13 Thompson		9/1	Ryan Wilson	2	E-9013	12	Susanville
WT E-20 Lunteys Mountain Wtr			Kevin Luntey	2	E-9020	24	Susanville
WT Outlands		9/7	Allen Williams	1	E-50030	12	Susanville
SOF1 Christensen		9/2	CC Christensen	1	O-24.5	12	Susanville
CRW FIRESTORM C-22			MAC NORZUE		C-22		
DOZ THOMPSON		9/13	SAM THOMPSON		E		
S/T ENG3 GUISC		9/13	SPALDING	24	E-50003		

6. Work Assignments:
Continue to mop up and secure fireline to prevent fire progression to the North to protect the residents and values in the Susanville area.
Continue to mop up and secure burn areas around structures to prevent ignition to the degree possible.
TF 3800

7. Special Instructions:
Backhaul all trash, modules need to take all trash back to ICP.
REMS 1 assigned to DIV P @ DP42 and REMS 2 assigned to DIV TT @ DP 88. Both are available Incident wide.
Avoidance Flagging: North Complex will be red and black candy stripe. Sheep Fire will be red and white candy stripe.

8. Communications							
Name	Ch	Function	Rx Freq	Rx Tone	Tx Freq	Tx Tone	Notes
NIFC C3	1	COMMAND	170.4250	T10 - 107.2	168.0750	T10 - 107.2	THOMPSON PEAK
VFIRE 22	7	TACTICAL	154.2650	156.7 (T6)	154.2650	156.7 (T6)	
SHEEP FIRE A/G CMD	13	A/G CMD	169.1500	None	169.1500	None	
SHEEP FIRE A/G TAC	14	A/G TAC	171.1125	None	171.1125	None	
CALCORD	15	Medical	156.0750	156.7 (T6)	156.0750	156.7 (T6)	
AIR GUARD	16	Emergency	168.6250	None	168.6250	110.9 (T1)	

9. Prepared by: Name: Danny Douglas / Kelly Mosinski(t)	RESL	Signature: <i>KMO</i>
ICS 204	Date/Time: 8/30/2020 2200	Personnel Count: 93

ASSIGNMENT LIST (ICS 204 WF)

CONTROLLED UNCLASSIFIED
INFORMATION//BASIC

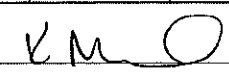
1. Incident Name: NORTH COMPLEX		2. Operational Period: Date From: 08/31/20 Date To: 09/01/20 Time From: 0700 Time To: 0700				3. Branch Division V - Sheep H Page 1 of 2 Hotel	
4. Operations Personnel:							
Sheep Fire Ops: Chris Childers / Jim Topoleski / Travis Thane (t)				Night Ops:			
Branch Director: Adam Mattos				Branch Safety:			
Division/Group Supervisor: Tim Williams / Jenn Corning (t)				Air Attack:			
5. Resources Assigned:							
Resource Identifier	ALS	LWD	Leader	Personnel	Request #	Hours	Reporting Location
S/T CRW LMU 9236G		4/5	Jeff Hohn	38	C-9004	12	Susanville
CRW2 Antelope 4			Hansen	14	C-9002	12	Susanville
CRW2 Antelope 2			Whit Church	14	C-9003	12	Susanville
S/T ENG1 9310A	9/8	9/8	Mark Scoville	16	E-50052	24	Susanville
S/T ENG3 9420C		9/3	Mark Pimentel	22	E-50000	24	Susanville
ENG3 LMU E 2272			Haugh	3	E-9064	24	Susanville
ENG3 LMU E 2254			Blaugh	4	E-9044	24	Susanville
ENG T/F OES 6900		9/6	Ortega	14-10*	E-50005	12-24	Susanville
ENG3 Scholl Fire		9/12	John Gates	3	E-173	12	Susanville
ENG3 Rogue River		9/3	Christian Huttima	5	E-9069	12	Susanville
DOZ2 LMU D 2242			Endicott / Stevenson	2	E-9002	12	Susanville
DOZ E-9 DG Backhoe			Simson	2	E-9009	12	Susanville
DOZ E-11 Shearer		9/1	Jim Shearer	2	E-9011	12	Susanville
DOZ2 Dadco			Cotten / Brolliar	2	E-50011	12	Susanville
WT E-17 Kirack			Kirak	2	E-9017	24	Susanville
WT E-15 Impact			Potter	2	E-9015	24	Susanville
WT E-18 Thompson Ent.			Primofiore/Powell	2	E-9018	24	Susanville
WT E-19 Tough Co. Fire Inc.		8/29	Duscee/Camcho	2	E-9019	24	Susanville
WT Johnson Construction		9/6	Lamarr/Patty	2	E-50031	24	Susanville
6. Work Assignments:							
Continue to mop up and improve firelines to secure the fire's edge while maintaining personnel safety.							
Mop up and secure burn areas around structures to prevent ignition to the degree possible.							
Construct contingency line to the east as necessary to protect the town of Janesville and surrounding homes.							
7. Special Instructions:							
Backhaul all trash, modules need to take all trash back to ICP.							
REMS 1 assigned to DIV P @ DP42 and REMS 2 assigned to DIV TT @ DP88. Both are available Incident wide.							
Avoidance Flagging: North Complex will be red and black candy stripe. Sheep Fire will be red and white candy stripe.							
8. Communications							
Name	Ch	Function	Rx Freq	Rx Tone	Tx Freq	Tx Tone	Notes
NIFC C3	1	COMMAND	170.4250	T10 - 107.2	168.0750	T10 - 107.2	THOMPSON PEAK
VFIRE 26	11	TACTICAL	154.3025	156.7 (T6)	154.3025	156.7 (T6)	
SHEEP FIRE A/G CMD	13	A/G CMD	169.1500	None	169.1500	None	
SHEEP FIRE A/G TAC	14	A/G TAC	171.1125	None	171.1125	None	
CALCORD	15	Medical	156.0750	156.7 (T6)	156.0750	156.7 (T6)	
AIR GUARD	16	Emergency	168.6250	None	168.6250	110.9 (T1)	
9. Prepared by: Name: Danny Douglas / Kelly Mosinski(t) RESL							
						Signature: 	
ICS 204		Date/Time: 8/30/2020 2200				Personnel Count: 147	

ASSIGNMENT LIST (ICS 204 WF)

CONTROLLED UNCLASSIFIED
INFORMATION//BASIC

1. Incident Name: NORTH COMPLEX			2. Operational Period: Date From: 08/31/20 Date To: 09/01/20 Time From: 0700 Time To: 0700				3. Branch V - Sheep		Division H
							Page 2 of 2		Hotel
4. Operations Personnel:									
Sheep Fire Ops: Chris Childers / Jim Topoleski / Travis Thane (t)					Night Ops:				
Branch Director: Adam Mattos					Branch Safety:				
Division/Group Supervisor: Tim Williams / Jenn Corning (t)					Air Attack:				
5. Resources Assigned:									
Resource Identifier	ALS	LWD	Leader	Personnel	Request #	Hours	Reporting Location		
WT McLane → D		9/7	Bill McLane	2	E-50034	24	Susanville		
WT Berlt			Berlt/Herrera	2		24	Susanville		
WT Tubit 1 → O/S 8/30-8/31			Anderson	2		24	Susanville		
WT Tubit 2			Kemp	2		24	Susanville		
WT Tubit 3			Wattenburg	2		24	Susanville		
WT Peters → Helibase		9/6	Tom Cutting	1	E-50026	12	Susanville		
FALM A & F Enterprises		9/10	Guay / Marshall	2	O-55	12	Susanville		
FALM Northzone 17		9/2	Carl Hall	2	O-102	12	Susanville		
REAF Immeker		9/4	David Immeker	1	O-221	12	Susanville		
ARCH(t) Allen		9/4	Tyler Allen	1	O-362	12	Susanville		
ARCH(t) Segroves		9/4	Adam Segroves	1	O-363	12	Susanville		
SOF2 Wofford		8/31	Lea Wofford	1	O-225	12	Susanville		
WT McClain									
6. Work Assignments:									
Continue to mop up and improve firelines to secure the fire's edge while maintaining personnel safety. Mop up and secure burn areas around structures to prevent ignition to the degree possible. Construct contingency line to the east as necessary to protect the town of Janesville and surrounding homes.									
7. Special Instructions:									
Backhaul all trash, modules need to take all trash back to ICP. REMS 1 assigned to DIV P @ DP42 and REMS 2 assigned to DIV TT @ DP88. Both are available Incident wide. Avoidance Flagging: North Complex will be red and black candy stripe. Sheep Fire will be red and white candy stripe.									
8. Communications									
Name	Ch	Function	Rx Freq	Rx Tone	Tx Freq	Tx Tone	Notes		
NIFC C3	1	COMMAND	170.4250	T10 - 107.2	168.0750	T10 - 107.2	THOMPSON PEAK		
VFIRE 26	11	TACTICAL	154.3025	156.7 (T6)	154.3025	156.7 (T6)			
SHEEP FIRE A/G CMD	13	A/G CMD	169.1500	None	169.1500	None			
SHEEP FIRE A/G TAC	14	A/G TAC	171.1125	None	171.1125	None			
CALCORD	15	Medical	156.0750	156.7 (T6)	156.0750	156.7 (T6)			
AIR GUARD	16	Emergency	168.6250	None	168.6250	110.9 (T1)			
9. Prepared by: Name:			Danny Douglas / Kelly Mosinski(t)			RESL			
						Signature: <i>KMO</i>			
ICS 204			Date/Time: 8/30/2020 2200			Personnel Count: 19			

ASSIGNMENT LIST (ICS 204 WF)

CONTROLLED UNCLASSIFIED
INFORMATION//BASIC

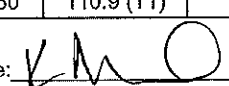
1. Incident Name: NORTH COMPLEX		2. Operational Period: Date From: 08/31/20 Date To: 09/01/20 Time From: 0700 Time To: 0700			3. Branch Division X- Bear AA Page 1 of 2 Alpha-Alpha		
4. Operations Personnel:							
North Complex Ops: Chad Cook / Mario Gomez(t)				Night Ops: David Kelly			
Branch Director: Don Fregulia / Kerri Gilliland (t)				Branch Safety:			
Division/Group Supervisor: Gene Neely / Chad Lauer (t)				Air Attack:			
5. Resources Assigned:							
Resource Identifier	ALS	LWD	Leader	Personnel	Request #	Hours	Reporting Location
CRW T2 Cat G		9/13	Dion Aexander	20	C-8	12	Quincy
ENG3 AFR 317		9/1	David Cruz	4	E-174	12	Quincy
ENG3 Fireant 322		8/31	Andrea McKenna	3	E-179	12	Quincy
ENG3 Canyon Ferry		9/3	Cindy DeBree	3	E-287	12	Quincy
ENG3 Rim Fire		9/2	Daniel Terrell	3	E-294	12	Quincy
ENG6 HB Forestry		8/31	Forrest Macdonnell	3	E-133	12	Quincy
ENG6 Volcano Creek		9/13	Amanda Gordon	3	E-257	12	Quincy
ENG6 Pacific Oasis		9/11	Jamal Kwiatkowski	3	E-459	12	Quincy
DOZ2 Wilburn Const.		9/5	Lee Braswell	2	E-111	12	Quincy
DOZ1 Bushey #9		9/2	Greg Cabral	2	E-126	12	Quincy
DOZ A & F Enterprises 9		9/2	Wayne Elliot	1	E-331	12	Quincy
FEL1-Market Forestry HA6 → TT		9/6	Phil Hansen	2	E-230	12	Quincy
SKG Softrack 270		9/11	Jonathan Oftedahl	2	E-270	12	Quincy
SKG2 Gehrke		9/6	Carl Gehrke	2	E-184	12	Quincy
SKG JB Logging		9/12	ANDY ALBERTSON	2	E-425	12	Quincy
SKD General Excavation		9/11	John Beirsto	2	E-362	12	Quincy
WT2 Woods Fire		9/13	Rock Woods	1	E-232	12	Quincy
WT Bluffdale 93			PAT LATHAM		E-370	12	Quincy
6. Work Assignments:							
Continue to construct indirect dozer line from DIV P to DP93. Line prep and safety zones should be constructed to contain northern progression.							
7. Special Instructions:							
Backhaul all trash, modules need to take all trash back to ICP. Ambulance Medic 3 assigned to Branch 10 @ DP 88 and available Branch wide. REMS 1 assigned to DIV P @ DP42 and REMS 2 assigned to DIV TT @ DP88. Both are available Incident wide. Avoidance Flagging: North Complex will be red and black candy stripe. Sheep Fire will be red and white candy stripe.							
8. Communications							
Name	Ch	Function	Rx Freq	Rx Tone	Tx Freq	Tx Tone	Notes
NIFC C10	1	COMMAND	170.4125	T10 - 107.2	165.9625	T10 - 107.2	Claremont Peak
VFIRE 23	10	TACTICAL	154.2950	156.7 (T6)	154.2950	156.7 (T6)	
NORTH COMPLEX A/G CMD	13	A/G CMD	167.9500	None	167.9500	None	
NORTH COMPLEX A/G TAC	14	A/G TAC	168.4000	None	168.4000	None	
CALCORD	15	Medical	156.0750	156.7 (T6)	156.0750	156.7 (T6)	
AIR GUARD	16	Emergency	168.6250	None	168.6250	110.9 (T1)	
9. Prepared by: Name: Danny Douglas / Kelly Mosinski(t) RESL							
						Signature: 	
ICS 204		Date/Time: 8/30/2020 2200			Personnel Count: 58		

ASSIGNMENT LIST (ICS 204 WF)

CONTROLLED UNCLASSIFIED
INFORMATION//BASIC

1. Incident Name:	2. Operational Period:	3. Branch	Division
NORTH COMPLEX	Date From: 08/31/20 Date To: 09/01/20 Time From: 0700 Time To: 0700	X- Bear	AA
		Page 2 of 2	Alpha-Alpha

4. Operations Personnel:	
North Complex Ops: Chad Cook / Mario Gomez(t) Branch Director: Don Fregulia / Kerri Gilliland (t) Division/Group Supervisor: Gene Neely / Chad Lauer (t)	Night Ops: David Kelly Branch Safety: Atr Attack:

5. Resources Assigned:							
Resource Identifier	ALS	LWD	Leader	Personnel	Request #	Hours	Reporting Location
WT Skyline 53		9/13	Stacey Buckingham	1	E-488	12	Quincy
FAL1 Saxon		9/12	Darwin Saxon	1	O-489	12	Quincy
TFLD (t) Reese		9/12	Greg Reese	1	O-419	12	Quincy
HEQB Bakos		9/13	Toby Bakos	1	O-431	12	Quincy
EMPF Sandler			Ron Sandler	1	O-505	12	Quincy
WT2 WESTERN FIRE			TRACY QUINN	1	E-348		
WT LOCKETT 24			JEFF REYNOLDS		E-490		
MASIZ MARKET FORESTRY			COLLIN LOKEN	2	E-429		FORBES

6. Work Assignments:
 Continue to construct indirect dozer line from DIV P to DP93.
 Line prep and safety zones should be constructed to contain northern progression.

7. Special Instructions:
 Backhaul all trash, modules need to take all trash back to ICP.
 Ambulance Medic 3 assigned to Branch 10 @ DP 88 and available Branch wide.
 REMS 1 assigned to DIV P @ DP42 and REMS 2 assigned to DIV TT @ DP88. Both are available Incident wide.
 Avoidance Flagging: North Complex will be red and black candy stripe. Sheep Fire will be red and white candy stripe.

8. Communications							
Name	Ch	Function	Rx Freq	Rx Tone	Tx Freq	Tx Tone	Notes
NIFC C10	1	COMMAND	170.4125	T10 - 107.2	165.9625	T10 - 107.2	Claremont Peak
VFIRE 23	10	TACTICAL	154.2950	156.7 (T6)	154.2950	156.7 (T6)	
NORTH COMPLEX A/G CMD	13	A/G CMD	167.9500	None	167.9500	None	
NORTH COMPLEX A/G TAC	14	A/G TAC	168.4000	None	168.4000	None	
CALCORD	15	Medical	156.0750	156.7 (T6)	156.0750	156.7 (T6)	
AIR GUARD	16	Emergency	168.6250	None	168.6250	110.9 (T1)	

9. Prepared by: Name:	Danny Douglas / Kelly Mosinski(t)	RESL	Signature:
ICS 204	Date/Time: 8/30/2020 2200	Personnel Count: 5	

ASSIGNMENT LIST (ICS 204 WF)

CONTROLLED UNCLASSIFIED
INFORMATION/BASIC

1. Incident Name: NORTH COMPLEX	2. Operational Period: Date From: 08/31/20 Date To: 09/01/20 Time From: 0700 Time To: 0700	3. Branch X-Bear Division MM Page 1 of 1 Mike-Mike
---	---	--

4. Operations Personnel: North Complex Ops: Chad Cook / Mario Gomez(t) Branch Director: Don Fregulia / Kerri Gilliland (t) Division/Group Supervisor: Patrick Callahan	Night Ops: David Kelly Branch Safety: Air Attack:
--	---

5. Resources Assigned:						
Resource Identifier	ALS	LWD	Leader	Personnel	Request #	Hours Reporting Location
ENG6 HAVES		9/13	LEE GRANT	3	E-482	
DOZ2 MAY			JIM HERSHKOWITZ		E-508	
DOZ ALLEN (FROM QR)		9/13	JOHN ALLEN		E-507	
DOZ PITTS			GRANT ANTILA		E-512	
DOZ V-WORKS		9/13	DON LINSTROM		E-356	

6. Work Assignments:
Scout line, then identify dozer lines to connect the Bear Fire to the 2008 Scotch Fire line scar and to the Middle Fork of the Feather River. Improve and prep the 22N2A Road from the QQ/MM break to County Road 119.

7. Special Instructions:
Backhaul all trash, modules need to take all trash back to ICP.
Ambulance Medic 3 assigned to Branch 10 @ DP88 and available Branch wide.
REMS 1 assigned to DIV P @ DP42 and REMS 2 assigned to DIV TT @ DP88. Both are available Incident wide.
Avoidance Flagging: North Complex will be red and black candy stripe. Sheep Fire will be red and white candy stripe.

8. Communications							
Name	Ch	Function	Rx Freq	Rx Tone	Tx Freq	Tx Tone	Notes
NIFC C10	1	COMMAND	170.4125	T10 - 107.2	165.9625	T10 - 107.2	Claremont Peak
NIFC T5	7	TACTICAL	166.7250	107.2 (T10)	166.7250	107.2 (T10)	
NORTH COMPLEX A/G CMD	13	A/G CMD	167.9500	None	167.9500	None	
NORTH COMPLEX A/G TAC	14	A/G TAC	168.4000	None	168.4000	None	
CALCORD	15	Medical	156.0750	156.7 (T6)	156.0750	156.7 (T6)	
AIR GUARD	16	Emergency	168.6250	None	168.6250	110.9 (T1)	

9. Prepared by: Name: Danny Douglas / Kelly Mosinski(t) RESL
Signature: 

ICS 204 Date/Time: 8/30/2020 2200 Personnel Count: 0

ASSIGNMENT LIST (ICS 204 WF)

CONTROLLED UNCLASSIFIED
INFORMATION/BASIC

1. Incident Name: NORTH COMPLEX		2. Operational Period: Date From: 08/31/20 Date To: 09/01/20 Time From: 0700 Time To: 0700			3. Branch Division X-Bear QQ Page 1 of 1 Quebec-Quebec		
4. Operations Personnel:							
North Complex Ops: Chad Cook / Mario Gomez(t) Branch Director: Don Fregulia / Kerri Gilliland (t) Division/Group Supervisor: Patrick Preston / Eric Borlaug (t)				Night Ops: David Kelly Branch Safety: Air Attack:			
5. Resources Assigned:							
Resource Identifier	ALS	LWD	Leader	Personnel	Request #	Hours	Reporting Location
ENG3 Gist Enterprises		9/12	Lew Wallace	3	E-306	12	Quincy
ENG3 TMU 341		9/10	Ted King	5	E-400	12	Quincy
DOZ1 Restad		9/3	Shawn Mahood	2	E-354	12	Quincy
DOZ2 LePage		9/5	Steve Brown	3	E-112	12	Quincy
DOZ2 Emery Farms		9/9	Sermon	1	E-148	12	Quincy
DOZ-Allen's-Dozer → MM		9/13	John Allen	1	E-507	12	Quincy
SKG Obadiah 1		9/12	Woody Chain	2	E-277 E-274	12	Quincy
SKG Allderdice		9/12	Lawrence Allderdice	2	E-422	12	Quincy
WT Brady's Backhoe		9/12	Jack Westmorelana	1	E-371	12	Quincy
WT Tough Equip		9/5	John Canter	1	E-487	12	Quincy
WT Hillside Fire T-15		9/13	Rick Bernbaum	1	E-499	12	Quincy
HEQB Bojorque		9/11	Will Bojorque	1	O-45	12	Quincy
READ Manning		9/8	Danny Manning	1	O-404	12	Quincy
REAF Maynard		9/10	Amaryillis Maynard	1	O-445	12	Quincy
READ Hodges			Stephen Hodges	1	O-266	12	Quincy
READ Miguel			Jeffery Miguel	1	O-99	12	Quincy
EMPF Gonzales		9/9	Casey Gonzales	1	O-366	12	Quincy
EMPF Spravzoff		9/9	Shane Spravzoff	1	O-364	12	Quincy
SOFR Foley		9/5	John Foley	1	O-246	12	Quincy
SOFR Cupp			Doug Cupp	1	O-503	12	Quincy
6. Work Assignments: Scout line, then identify dozer lines to connect the Bear Fire to the 2008 Scotch Fire line scar. Build dozer line from Section 26 to 36 to contain Willow Creek Fire spread.							
7. Special Instructions: Backhaul all trash, modules need to take all trash back to ICP. Ambulance Medic 3 assigned to Branch 10 @ DP88 and available Branch wide. REMS 1 assigned to DIV P @ DP 42 and REMS 2 assigned to DIV TT @ DP88. Both are available Incident wide. Avoidance Flagging: North Complex will be red and black candy stripe. Sheep Fire will be red and white candy stripe.							
8. Communications							
Name	Ch	Function	Rx Freq	Rx Tone	Tx Freq	Tx Tone	Notes
NIFC C10	1	COMMAND	170.4125	T10 - 107.2	165.9625	T10 - 107.2	Claremont Peak
VFIRE 24	11	TACTICAL	154.2725	156.7 (T6)	154.2725	156.7 (T6)	
NORTH COMPLEX A/G CMD	13	A/G CMD	167.9500	None	167.9500	None	
NORTH COMPLEX A/G TAC	14	A/G TAC	168.4000	None	168.4000	None	
CALCORD	15	Medical	156.0750	156.7 (T6)	156.0750	156.7 (T6)	
AIR GUARD	16	Emergency	168.6250	None	168.6250	110.9 (T1)	
9. Prepared by: Name: Danny Douglas / Kelly Mosinski(t) RESL Signature: <u>KM O</u>							
ICS 204		Date/Time: 8/30/2020 2200		Personnel Count: 29			

ASSIGNMENT LIST (ICS 204 WF)

CONTROLLED UNCLASSIFIED
INFORMATION//BASIC

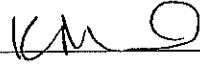
1. Incident Name: NORTH COMPLEX		2. Operational Period: Date From: 08/31/20 Date To: 09/01/20 Time From: 0700 Time To: 0700			3. Branch Division X- Bear TT		
					Page 1 of 2 Tango-Tango		
4. Operations Personnel:							
North Complex Ops: Chad Cook / Mario Gomez(t)				Night Ops: David Kelly			
Branch Director: Don Fregulia / Kerri Gilliland (t)				Branch Safety:			
Division/Group Supervisor: Richard Ingram / Clint Isbell (t)				Air Attack:			
5. Resources Assigned:							
Resource Identifier	ALS	LWD	Leader	Personnel	Request #	Hours	Reporting Location
CRW T2IA Shasta Lake		9/9	Ron Graves	19	C-33	12	Quincy
GRW T2 SES Fire → X/SN		9/13	Darrell Sam	20	C-9	12	Quincy
S/T ENG3 3675C		9/9	Keith Smyth	26	E-59	12	Quincy
ENG3 Bailey Ent.		9/1	Greg Bailey	3	E-256	12	Quincy
ENG3 Wildfire Resources		9/10	Reagen Farly	3	E-289	12	Quincy
ENG3 AAA Forestry 412		9/11	Paul Huddlestun	3	E-412	12	Quincy
ENG4 HI Country 1029		9/14	Taryn Thomas	3	E-144	12	Quincy
ENG6 Pierce Fire		9/6	Michael Lawrence	3	E-135	12	Quincy
S/T DOZ2 9360L			Mike Grisedale	6	E-525	24	Quincy
DOZ2 Brown		9/9	Barry Brown	2	E-262	12	Quincy
DOZ2 Spencer		9/8	Mike Spencer	2	E-264	12	Quincy
DOZ2 Goose Creek		9/8	Will Bedke	2	E-265	12	Quincy
DOZ2 Lonestar 7		9/2	Jesse Crabtree	2	E-329	12	Quincy
DOZ2 PNF 2		8/31	Brandon Delong	2	E-334	12	Quincy
FEL1 JW Bamford		9/5	Nathan Bamford	2	E-73	12	Quincy
FEL1 Tyrell Resources		9/4	Corey VanMeter	1	E-75	12	Quincy
FEL2 Warner Ent.		9/4	Robert Allen	2	E-74	12	Quincy
SKG Soft Track Attack 268		9/10	Jeremy Nelson	3	E-268	12	Quincy
6. Work Assignments: Construct indirect line from DIV AA - DP88 southwest to DP90. This will be the containment line for the northwest section of Bear Fire.							
7. Special Instructions: Backhaul all trash, modules need to take all trash back to ICP. Ambulance Medic 3 assigned to Branch 10 @ DP88 and available Branch wide. REMS 1 assigned to DIV P @ DP42 and REMS 2 assigned to DIV TT @ DP88. Both are available Incident wide. Avoidance Flagging: North Complex will be red and black candy stripe. Sheep Fire will be red and white candy stripe.							
8. Communications							
Name	Ch	Function	Rx Freq	Rx Tone	Tx Freq	Tx Tone	Notes
NIFC C10	1	COMMAND	170.4125	T10 - 107.2	165.9625	T10 - 107.2	Claremont Peak
NIFC T7	9	TACTICAL	168.2500	107.2 (T10)	168.2500	107.2 (T10)	
NORTH COMPLEX A/G CMD	13	A/G CMD	167.9500	None	167.9500	None	
NORTH COMPLEX A/G TAC	14	A/G TAC	168.4000	None	168.4000	None	
CALCORD	15	Medical	156.0750	156.7 (T6)	156.0750	156.7 (T6)	
AIR GUARD	16	Emergency	168.6250	None	168.6250	110.9 (T1)	
9. Prepared by: Name: Danny Douglas / Kelly Mosinski(t) RESL							
						Signature: 	
ICS 204		Date/Time: 8/30/2020 2200			Personnel Count: 104		

ASSIGNMENT LIST (ICS 204 WF)

CONTROLLED UNCLASSIFIED
INFORMATION//BASIC

1. Incident Name: NORTH COMPLEX	2. Operational Period: Date From: 08/31/20 Date To: 09/01/20 Time From: 0700 Time To: 0700	3. Branch Division X- Bear TT Page 2 of 2 Tango-Tango
--	---	--

4. Operations Personnel: North Complex Ops: Chad Cook / Mario Gomez(t) Branch Director: Don Fregulia / Kerri Gilliland (t) Division/Group Supervisor: Richard Ingram / Clint Isbell (t)	Night Ops: David Kelly Branch Safety: Air Attack:
--	--

5. Resources Assigned:							
Resource Identifier	ALS	LWD	Leader	Personnel	Request #	Hours	Reporting Location
SKG Soft Track Attack 269		9/10	Zack Bugli	2	E-269	12	Quincy
SKD Wood River 3-		9/10	Ray Driscoll	2	E-360	12	Quincy
WT Partridge		9/12	David Simonsen	1	E-374	12	Quincy
WT Saw Livin T-5		9/13	Patrick Sullivan	1	E-495	12	Quincy
WT Western Fire 492		9/13	Rick Lauman	1	E-492	12	Quincy
HEQB Young		9/11	Aaron Young	1	O-429	12	Quincy
HEQB (t) Sirriner		9/11	Eric Sirriner	1	O-447	12	Quincy
HEQB (t) Burris		9/13	Kenton Burris	1	O-511	12	Quincy
FAL1 Schwartz		9/13	Theodore Schwartz	1	O-490	12	Quincy
REAF (t) Bauer		9/8	Rachel Bauer	1	O-407	12	Quincy
REMS 2			Adam Mack	4	E-458	12	Quincy
SOFR Foley		9/5	John Foley	1	O-246	12	Quincy
WT2 SAW LIVIN #3			DOYLE NELSON		E-496		
HEQB FOURTNER			CHRISTOPHER FOURTNER		O-497		
FELI MARKET FORESTRY			(FROM AA)		E-230		

6. Work Assignments:
Construct indirect line from DIV AA - DP88 southwest to DP90. This will be the containment line for the northwest section of Bear Fire.

7. Special Instructions:
Backhaul all trash, modules need to take all trash back to ICP.
Ambulance Medic 3 assigned to Branch 10 @ DP88 and available Branch wide.
REMS 1 assigned to DIV P @ DP42 and REMS 2 assigned to DIV TT @ DP88. Both are available Incident wide.
Avoidance Flagging: North Complex will be red and black candy stripe. Sheep Fire will be red and white candy stripe.

8. Communications							
Name	Ch	Function	Rx Freq	Rx Tone	Tx Freq	Tx Tone	Notes
NIFC C10	1	COMMAND	170.4125	T10 - 107.2	165.9625	T10 - 107.2	Claremont Peak
NIFC T7	9	TACTICAL	168.2500	107.2 (T10)	168.2500	107.2 (T10)	
NORTH COMPLEX A/G CMD	13	A/G CMD	167.9500	None	167.9500	None	
NORTH COMPLEX A/G TAC	14	A/G TAC	168.4000	None	168.4000	None	
CALCORD	15	Medical	156.0750	156.7 (T6)	156.0750	156.7 (T6)	
AIR GUARD	16	Emergency	168.6250	None	168.6250	110.9 (T1)	

9. Prepared by: Name:	Danny Douglas / Kelly Mosinski(t)	RESL	Signature:
ICS 204	Date/Time: 8/30/2020 2200	Personnel Count: 17	

ASSIGNMENT LIST (ICS 204 WF)

CONTROLLED UNCLASSIFIED
INFORMATION/BASIC

1. Incident Name: NORTH COMPLEX	2. Operational Period: Date From: 08/31/20 Date To: 09/01/20 Time From: 0700 Time To: 0700	3. Branch SPG	Division Stucture Protect
4. Operations Personnel: North Complex Ops: Chad Cook / Mario Gomez(t) Branch Director: Division/Group Supervisor: Garrett Prater / Jason Bunker (t)		Night Ops: David Kelly Branch Safety: Air Attack:	

5. Resources Assigned:							
Resource Identifier	ALS	LWD	Leader	Personnel	Request #	Hours	Reporting Location
S/T ENG1 OES 4808A	Yes	9/13	Greg Powell	22	E-12	12	Quincy
S/T ENG1 OES 4807A		9/13		22	E-281	12	Quincy
S/T ENG1 LFD 1003A		9/11	Jason Hing	22	E-386	12	Quincy
ENG1 BEC 9424		9/1	Thompson	4	E-324	12	Quincy
ENG1 QUI 8124		9/1	Kevin Correira	4	E-325	12	Quincy
ENG1 GRA 9225		9/7	Cody Ward	3	E-326	12	Quincy
ENG1 GHC 8324		8/31	Charley Reid	4	E-253	12	Quincy
ENG3 GHC 8372		9/6	Tyler Marshall	4	E-254	12	Quincy
ENG6 Harrison 56		9/6	Nathan Comar	2	E-132	12	Quincy
DOZ2 Lonestar 8		9/12	B Marshall / M Gooden	2	E-330	12	Quincy
TFLD Rael			Tyson Rael	1		12	Quincy

6. Work Assignments:
Develop structure protection plan for Highland and Ontop structures to protect private property from the Bear Fire.
Continue to prep structures, and private property in Highlands subdivision and Ontop Mine.

7. Special Instructions:
Structure Protection Group will report directly to OPS for assignments.
Backhaul all trash, modules need to take all trash back to ICP.
Ambulance Medic 2 @ DP57 assigned to Branch 2 available Branch wide.
REMS 1 assigned to DIV P @ DP42 and REMS 2 assigned to DIV TT @ DP88. Both are available Incident wide.
Avoidance Flagging: North Complex will be red and black candy stripe. Sheep Fire will be red and white candy stripe.

8. Communications							
Name	Ch	Function	Rx Freq	Rx Tone	Tx Freq	Tx Tone	Notes
NIFC C10	1	COMMAND	170.4125	T10 - 107.2	165.9625	T10 - 107.2	Claremont Peak
VFIRE 25	12	TACTICAL	154.2875	156.7 (T6)	154.2875	156.7 (T6)	
NORTH COMPLEX A/G CMD	13	A/G CMD	167.9500	None	167.9500	None	
NORTH COMPLEX A/G TAC	14	A/G TAC	168.4000	None	168.4000	None	
CALCORD	15	Medical	156.0750	156.7 (T6)	156.0750	156.7 (T6)	
AIR GUARD	16	Emergency	168.6250	None	168.6250	110.9 (T1)	

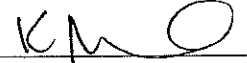
9. Prepared by: Name: Danny Douglas / Kelly Mosinski(t)	RESL	Signature: 
ICS 204	Date/Time: 8/30/2020 2200	Personnel Count: 90

ASSIGNMENT LIST (ICS 204 WF)

CONTROLLED UNCLASSIFIED
INFORMATION//BASIC

1. Incident Name: NORTH COMPLEX	2. Operational Period: Date From: 08/31/20 Date To: 09/01/20 Time From: 0700 Time To: 0700	3. Branch Division IA / Patrol
--	---	--

Page 1 of 1

4. Operations Personnel: North Complex Ops: Chad Cook / Mario Gomez(t) Branch Director: Division/Group Supervisor: Jordan Townsend	Night Ops: David Kelly Branch Safety: Air Attack:
--	--

5. Resources Assigned:							
Resource Identifier	ALS	LWD	Leader	Personnel	Request #	Hours	Reporting Location
ENG3 Indian Valley 7673		8/31	Jeremy Griffin	3	E-5	12	Quincy
ENG3 PNF 22		9/6	Roman Rodriguez	4	E-247	12	Quincy
ENG3 CNF 326		9/2	Chris Olsen	5	E-241	12	Quincy
ENG3 PNF 325		9/1	Clayton Beck	5	E-332	12	Quincy
ENG3 PNF 320		9/4	Collin Shafer	5	E-335	12	Quincy

6. Work Assignments:
 Continue to patrol contained fires. Secure and mop up where necessary.
 Suppress any new Initial Attack Fire on the Mt. Hough Ranger District.

7. Special Instructions:
 Backhaul all trash, modules will need to take all trash back to ICP.
 REMS 1 assigned to DIV P @ DP42 and REMS 2 assigned to DIV TT @ DP88. Both are available Incident wide.
 Avoidance Flagging: North Complex will be red and black candy stripe. Sheep Complex will be red and white candy stripe.

8. Communications							
Name	Ch	Function	Rx Freq	Rx Tone	Tx Freq	Tx Tone	Notes
NIFC C10	1	COMMAND	170.4125	T10 - 107.2	165.9625	T10 - 107.2	Claremont Peak
NIFC T2	9	TACTICAL	168.2000	107.2 (T10)	168.2000	107.2 (T10)	
NORTH COMPLEX A/G TAC	14	A/G TAC	168.4000	None	168.4000	None	
CALCORD	15	Medical	156.0750	156.7 (T6)	156.0750	156.7 (T6)	
AIR GUARD	16	Emergency	168.6250	None	168.6250	110.9 (T1)	

9. Prepared by: Name: Danny Douglas / Kelly Mosinski(t) RESL Signature:

ICS 204 Date/Time: 8/30/2020 2200 Personnel Count: 22

ASSIGNMENT LIST (ICS 204 WF)

CONTROLLED UNCLASSIFIED
INFORMATION/BASIC

1. Incident Name: NORTH COMPLEX	2. Operational Period: Date From: 08/31/20 Date To: 09/01/20 Time From: 1900 Time To: 0700	3. Branch Division Night
--	---	--

Page 1 of 1

4. Operations Personnel: North Complex Ops: Chad Cook / Mario Gomez(t) Branch Director: Division/Group Supervisor: Jason Jensen / Mark Hansen (t)	Night Ops: David Kelly Branch Safety: Air Attack:
---	--

5. Resources Assigned:							
Resource Identifier	ALS	LWD	Leader	Personnel	Request #	Hours	Reporting Location
S/T ENG3 4129C		9/12	Richard Holmes	22	E-461	12	Quincy
ENG3 Mountain Camel		9/4	Shawn Wippert	3	E-6	12	Quincy
ENG3 Castle Mt. 15		9/2	Scott McHenery	3	E-282	12	Quincy
ENG3 Castle Mt. 16		9/2	Chase Cork	3	E-283	12	Quincy
ENG3 Cahoon 3		9/2	Shawn Dubray	3	E-284	12	Quincy
ENG6 3648		9/8	Mike Hoon	3	E-267	12	Quincy
DOZ2 Lonestar 8		9/12	B Marshall / M Gooden	2	E-330	12	Quincy
SKG1 Soft Track 182		9/7	Detwiler / Guthrie	2	E-182	12	Quincy
SOFR Birg		9/10	Jeff Birg	1	O-371	12	Quincy

6. Work Assignments:
Continue to prep, fire, and hold containment and indirect lines in Branch II.

7. Special Instructions:
Use the Tactical Frequency assigned for the Division you are working in.
Backhaul all trash, modules need to take trash back to ICP.
Avoidance Flagging: North Complex red and black candy stripe. Sheep Fire will be red and white candy stripe.
Ambulances are assigned and available at the ICP and Susanville base at night.
REMS 1 assigned to DIV P @ DP42 and REMS 2 assigned to DIV TT @ DP88. Both are available Incident wide.

8. Communications							
Name	Ch	Function	Rx Freq	Rx Tone	Tx Freq	Tx Tone	Notes
NIFC C10	1	COMMAND	170.4125	T10 - 107.2	165.9625	T10 - 107.2	Claremont Peak
NORTH COMPLEX A/G CMD	13	A/G CMD	167.9500	None	167.9500	None	
NORTH COMPLEX A/G TAC	14	A/G TAC	168.4000	None	168.4000	None	
CALCORD	15	Medical	156.0750	156.7 (T6)	156.0750	156.7 (T6)	
AIR GUARD	16	Emergency	168.6250	None	168.6250	110.9 (T1)	

9. Prepared by: Name:	Danny Douglas / Kelly Mosinski(t)	RESL
		Signature:
ICS 204	Date/Time: 8/30/2020 2200	Personnel Count: 42

DIVISION ASSIGNMENT LIST		Branch	Division/Group						
Incident Name			<i>Contingency</i>						
		Operational Period							
		Date:	Time:						
Operations Personnel									
Operations Chief		Branch Director							
Safety Officer		Division/Group Supervisor		<i>Ray Torres / Chris King (+)</i>					
Resources Assigned This Period									
Strike Team/Task Force/ Resource Designator	Req#	Last Shift	Leader	# Persons	Drop Off Point /Time	Pick Up Point / Time			
<i>DOZ 2 Swagent Ent.</i>	<i>E-5B</i>		<i>Keith Maddox + GO TOBY Correa</i>	<i>2</i>					
Work Assignments (Task and Purpose)									
Task:									
Purpose:									
End State (Desired outcome and Time Frame)									
Special Instructions									
Division/Group Communication Summary									
Function	Frequency RX	Frequency TX	TO NE RX	TO NE TX	Channel	Function	Frequency RX	Frequency TX	Channel
Command						A/G Pri			
Command						A/G Sec			
Tactical									
Prepared by		Approved By			Date		Time		

North Complex

SAFETY MESSAGE

August 31-September 1st

VEHICLE CHECKS

Vehicle accidents are the number one cause of death for wildland firefighters

- Equipment checks are part of our daily routine
- Don't let compliancy creep into your process because you find nothing wrong day after day
- Don't assume new vehicles are infallible
- The environment we work in can rapidly have an adverse effect on our vehicles, especially tires and suspension parts
- Check tires for pressure and damage daily or after travel on rough roads
 - The loss of a steer tire on a high profile vehicle can easily cause a roll over or loss of control
- Check steering components (drag links, control arms) for excessive play
 - Loose components are an indicator of worn ball joints which can fail expectantly at any time

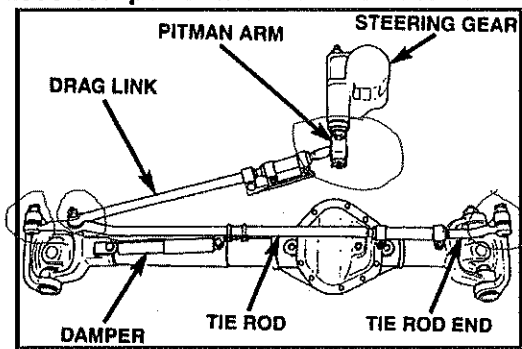

- Even though modern slack adjusters keep brakes adjusted automatically they only work if all parts are present. Make sure all pins etc. are there

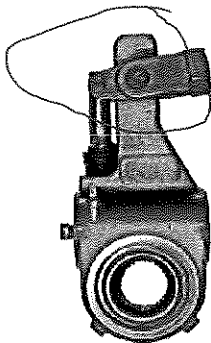

- Use backers
 - It is very embarrassing to hit something with multiple people in the vehicle
- At every stop walk around vehicle to check for water bottles/radios/open compartments
- Downshift while traveling downhill on steep grades. Engines and other heavy vehicles coming down steep grades should be either using an engine brake or low gear. Grade will over heat brakes without assistance.

INCIDENT SAFETY ANALYSIS 215a

North Complex and Sheep Fire - Monday, August 31, 2020

8. Location	9. Hazard	6. Control or Abatement Action (Engineering, Administrative, PPE, Avoidance, Education, etc)
All	Air Operations	<ul style="list-style-type: none"> ~ Ensure positive communication with all air resources. ~ Don't plan on air resources for medical transport or resupply. ~ Follow "Aviation Watch-Out Situations" IRPG Pg 46. ~ Refer to "Directing Bucket or Retardant Drops" IRPG Pg 58 . ~ Refer to "Aerial Retardant Safety" IRPG Pg57. ~ Refer to "Aircraft Mishap Response Procedure" IRPG Pg 62.
All	Hazard Trees	<ul style="list-style-type: none"> ~ Follow "Hazard Tree Safety" guidelines, IRPG page 22. ~ Post lookouts, or use a spotter in mop-up areas with personnel. ~ Don't park vehicles or take breaks in high concentrations of hazard trees. ~ Establish trigger points for disengagement during high wind events. ~ Remember that the hazard zone extends a minimum of 2 1/2 tree heights.
All	Extreme Fire Behavior	<ul style="list-style-type: none"> ~ Share weather observations with all personnel assigned to division. ~ Establish "Trigger Points" to withdraw. ~ Use "Risk Management" process prior to engaging in suppression actions IRPG Pg 1. ~ Refer to "Common Denominators of Fire Behavior Tragedy Fires" IRPG Pg 5. ~ Refer to "Alignments & Patterns for Dangerous Fire Behavior" IRPG Pg 73
All	Injury & Medical Emergency	<ul style="list-style-type: none"> ~ Assist injured employee appropriate medical care. ~ Use EMT's on Division for initial care. ~ Follow "Emergency Medical Care" IRPG Pgs 105-118 ~ Follow procedures in Medical Plan, ICS 206 ~ Refer to "Planning for Medical Emergencies" IRPG Pg 2
Br X	Indirect Fireline	<ul style="list-style-type: none"> ~ Post lookouts, identify escape routes and safety zones IRPG Pg. 7 ~ Review "Strategy Direct/Indirect Attack" IRPG Pg. 82-83 ~ Refer to "Line Location" IRPG Pg 84
All	Driving & Traffic	<ul style="list-style-type: none"> ~ Practice "Defensive Driving" techniques traveling on all roads and city streets. ~ Use spotters & Honk horn to alert personnel when backing. ~ Follow Driving LCES (Lights, Chock blocks, Emergency brake, Seat belts). ~ Always use headlights. ~ Yield to pedestrians and bicycles. ~ Observe posted speed limits. ~ Use the 3 second rule for following distance when driving. ~ Use chock blocks, turn wheels into hill. ~ Avoid distractions (eating, cell phones, radio). ~ Ensure that windshields are kept clean of dust and bugs. ~ Refer to "Smoke and Transportation Safety" IRPG Pg 31 ~ Refer to "Roadside Response Safety" IRPG Pg 26
All	Fatigue & Over Exertion	<ul style="list-style-type: none"> ~ Drink 1 quart of water each hour during and after work. ~ Rotate crews out of smoky areas. ~ Set a reasonable work pace and allow adequate rest breaks while on the project. ~ Stagger work crews start time to limit fatigue. ~ Use buddy system to monitor personnel of heat related and fatigue issues. ~ Follow work / rest guidelines.
Br II & X	Steep Terrain & Rolling Debris	<ul style="list-style-type: none"> ~ Maintain 8'-10' spacing when working & walking. ~ Don't work above any personnel. ~ Be on the lookout for rolling rocks, debris, or burning material. ~ Evaluate necessity to send personnel in areas with limited access. ~ Post lookouts IRPG Pg 7

INCIDENT SAFETY ANALYSIS 215a

All	Heavy Equipment Operations	<ul style="list-style-type: none"> ~ Refer to "Working with Heavy Equipment" IRPG Pg 86 ~ Ensure communications are established with operators. ~ Use hand signals if other communications are unavailable. ~ Maintain a 50'-100' exclusion area around equipment and increase it to 1 1/2 times tree height when in timber. ~ Use a spotter when backing. ~ Avoid working below heavy equipment.
All	Chain Saw Operations	<ul style="list-style-type: none"> ~ Follow "Hazard Tree Safety" guidelines, IRPG Pg 22 ~ Follow "Procedural Felling Operations" IRPG Pg 85. ~ Look up, Look down, Look around for hazard tree indicators. ~ Only fell and buck trees within your expertise, and training. ~ Do not fall trees during high wind events. ~ Ensure proper use of all required PPE.
BR II & X	Firing Operations & Devices	<ul style="list-style-type: none"> ~ Only personnel trained in the use of each device will be authorized to use firing equipment. ~ Ensure all personnel are aware of firing operation that may affect them. ~ Wear appropriate PPE. ~ Ensure aerial/ground ignition plans have been adequately developed and personnel are briefed.
All	Communications	<ul style="list-style-type: none"> ~ Maintain communication with aviation resources, and suppression organization. ~ Ensure all know frequency and protocol for contacting resources. ~ Utilize the ICS 205. ~ Utilize human repeaters when working in dead spots.
Br II	Night Operations	<ul style="list-style-type: none"> ~ Maintain high visibility in work area and wear vest while in roadway. ~ Use glow sticks to mark hazards. ~ Ensure personnel have a personal light (headlamp). ~ Watch for signs of fatigue. ~ Take breaks away from areas of known hazard.
Br X	ATV/UTV use	<ul style="list-style-type: none"> ~ Ensure equipment is inspected and safe to use. ~ Restrict UTV's to max width of 50" on ATV trails due to width and severe out sloped conditions. ~ Ensure operator is trained and certified to operate. ~ Ensure operator has proper PPE according to the Redbook and/or RMA. ~ Question if it is mission critical.
Br II & Sheep	Mop-up & Rehab	<ul style="list-style-type: none"> ~ Do not work above or below personnel during rehab/mop-up operations. ~ Alert crew personnel of rolling debris by yelling to affected individuals. ~ Position debris that could roll vertically on slope. ~ Wear eye protection.
All	Wildlife & Livestock	<ul style="list-style-type: none"> ~ Watch out for wildlife & livestock inside fire area and along roadways. ~ Clean up all debris and trash during each operational period.
All	Mines	<ul style="list-style-type: none"> ~ Identify and avoid mining areas. ~ Notify others of hazard.

INCIDENT RADIO COMMUNICATIONS PLAN ICS 205		Incident Name (Version 5)		Date/Time Prepared		Operational Period Date/Time					
North Complex		8/30/2020 2100 Hrs		8/31/20 0700 - 9/1/20 0700							
CONTROLLED UNCLASSIFIED INFORMATION/BASIC											
CH	Function	Channel Name/Trunked Talkgroup	Assignment	RX Freq	RX Tone/NAC	TX Freq	TX Tone/NAC	Dev	Pwr	Mode A, D, M	Remarks
1	Command	NIFC C10	Claremont and Bear Fire	170.4125	107.2 Tone 10	165.9625	107.2 Tone 10	N	H	A	Claremont Peak
2	Command	NIFC C26	Claremont and Bear Fire	172.5500	107.2 Tone 10	164.8625	107.2 Tone 10	N	H	A	Mt. Hough
3	Command	NIFC C47	Bear Fire	172.0750	107.2 Tone 10	162.2000	107.2 Tone 10	N	H	A	Franklin Hill
4	Command	NIFC C56	Bear Fire	168.1375	107.2 Tone 10	162.9375	107.2 Tone 10	N	H	A	Whiskey Hill
5	Tactical	NIFC T1	Div. V / S / X	168.0500	107.2 Tone 10	168.0500	107.2 Tone 10	N	H	A	
6	Tactical	NIFC T3	Div. P	168.6000	107.2 Tone 10	168.6000	107.2 Tone 10	N	H	A	
7	Tactical	NIFC T5	Div. MM	166.7250	107.2 Tone 10	166.7250	107.2 Tone 10	N	H	A	
8	Tactical	NIFC T6	Div. Z	166.7750	107.2 Tone 10	166.7750	107.2 Tone 10	N	H	A	
9	Tactical	NIFC T7	Div. TT	168.2500	107.2 Tone 10	168.2500	107.2 Tone 10	N	H	A	
10	Tactical	VFIRE23	Div. AA	154.2950	156.7 Tone 6	154.2950	156.7 Tone 6	N	H	A	
11	Tactical	VFIRE24	Div. QQ	154.2725	156.7 Tone 6	154.2725	156.7 Tone 6	N	H	A	
12	Tactical	VFIRE25	Structure Group	154.2875	156.7 Tone 6	154.2875	156.7 Tone 6	N	H	A	
13	Air to Ground	A/G CMD	All Divisions	167.9500	None	167.9500	None	N	H	A	
14	Air to Ground	A/G TAC	All Divisions	168.4000	None	168.4000	None	N	H	A	
15	Tactical	CALCORD	Medical	156.0750	156.7 Tone 6	156.0750	156.7 Tone 6	N	H	A	
16/20	Emergency	AIR GUARD	Emergency	168.6250	None	168.6250	110.9 Tone 1	N	H	A	

Prepared By (Communications Unit Leader) *Kody Kenwin*
 Incident Location: Quincy, CA
 Latitude Longitude W

Communications Unit (619) 359-3983 or (619) 383-6887



INCIDENT RADIO COMMUNICATIONS PLAN ICS 205		Incident Name (Version 4)		Date/Time Prepared		Operational Period Date/Time					
		Sheep Fire		8/30/2020 2100 Hrs		8/31/20 0700 - 9/1/20 0700					
CONTROLLED UNCLASSIFIED INFORMATION/BASIC											
CH	Function	Channel Name/Talked Talkgroup	Assignment	EX Freq	RX Tone/NAC	IX Freq	Tx Tone/NAC	Dev	Pwr	Mode A, D, M	Remarks
1	Command	NIFC C3	Sheep Fire	170.4250	107.2 Tone 10	168.0750	107.2 Tone 10	N	H	A	Thompson Peak
2	Command	NIFC C46	Sheep Fire	172.0875	107.2 Tone 10	162.1750	107.2 Tone 10	N	H	A	Peg Leg Mtn.
3	Command	NIFC C32	Sheep Fire	171.0875	107.2 Tone 10	164.0125	107.2 Tone 10	N	H	A	Red Rock
4											
5	Command	LMU T2	Medical	151.2500	123.0 Tone 2	159.4050	123.0 Tone 2	N	H	A	"Susanville" Tone 2 Dyer
6	Command	LMU T7	Medical	151.2500	123.0 Tone 2	159.405	167.9 Tone 7	N	H	A	"Susanville" Tone 7 Roop
7	Tactical	VFIRE22	Div. F	154.2650	156.7 Tone 6	154.2650	156.7 Tone 6	N	H	A	
8	Tactical	VFIRE23	Div. D	154.2950	156.7 Tone 6	154.2950	156.7 Tone 6	N	H	A	
9	Tactical	VFIRE24	Div. A	154.2725	156.7 Tone 6	154.2725	156.7 Tone 6	N	H	A	
10	Tactical	VFIRE25	Div. B	154.2875	156.7 Tone 6	154.2875	156.7 Tone 6	N	H	A	
11	Tactical	VFIRE26	Div. H	154.3025	156.7 Tone 6	154.3025	156.7 Tone 6	N	H	A	
12	Tactical	NIFC T3	Div. M	168.6000	107.2 Tone 10	168.6000	107.2 Tone 10	N	H	A	
13	Air to Ground	A/G CMD	All Divisions	169.1500	None	169.1500	None	N	H	A	
14	Air to Ground	A/G TAC	All Divisions	171.1125	None	171.1125	None	N	H	A	
15	Tactical	CALCORD	Medical	156.0750	156.7 Tone 6	156.0750	156.7 Tone 6	N	H	A	
16/20	Emergency	AIR GUARD	Emergency	168.6250	None	168.6250	110.9 Tone 1	N	H	A	
Prepared By (Communications Unit Leader)				Incident Location: Susanville, CA				Latitude		N Longitude W	
Kody Kerwin				Cnty:							
Communications Unit (619) 359-3983 or (619) 383-6887											

IA GROUP



INCIDENT RADIO COMMUNICATIONS PLAN ICS 205		Incident Name (Version 4)		Date/Time Prepared		Operational Period Date/Time													
		North Complex - IA Group		8/27/2020 2100 Hrs		Initial Attack Group													
CONTROLLED UNCLASSIFIED INFORMATION/BASIC																			
CH	Function	Channel Name/Trunked Talkgroup	Assignment	RX Freq	RX Tone/NAC	IX Freq	TX Tone/NAC	Dev	Pwr	Mode A, D, M	Remarks								
1	Dispatch	PNF	Plumas Forest Net	170.5500	None	164.8750	OST / MPL	N	H	A	"Plumas"								
2	Dispatch	PNF Adm	Plumas Admin Net	171.4250	None	163.1625	OST / MPL	N	H	A	"Plumas"								
3																			
4																			
5																			
6	Tactical	CDF T1	Cal Fire Tac 1	151.2575	192.8 Tone 16	151.2575	192.8 Tone 16	N	H	A									
7	Air to Ground	CDF A/G2	Cal Fire Air to Ground 2	159.2625	192.8 Tone 16	159.2625	192.8 Tone 16	N	H	A									
8	Air to Ground	CDF A/G1	Cal Fire Air to Ground 1	151.2200	192.8 Tone 16	151.2200	192.8 Tone 16	N	H	A									
9	Tactical	NIFC T2	IA Tactical	168.2000	None	168.2000	None	N	H	A									
10	Tactical	R5 T4	IA Tactical	166.5500	None	166.5500	None	N	H	A									
11	Tactical	R5 T5	IA Tactical	167.1125	None	167.1125	None	N	H	A									
12	Tactical	VFIRE22	IA Tactical	154.2650	156.7 Tone 6	154.2650	156.7 Tone 6	N	H	A									
13	Air to Ground	A/G 14	Plumas Primary	167.5000	None	167.5000	None	N	H	A									
14	Air to Ground	A/G 59	Plumas Secondary	169.1125	None	169.1125	None	N	H	A									
15	Tactical	CALCORD	Interoperability	156.0750	156.7 Tone 6	156.0750	156.7 Tone 6	N	H	A									
16/20	Emergency	AIRGUARD	Emergency	168.6250	None	168.6250	110.9 Tone 1	N	H	A									
Prepared By (Communications Unit Leader)				Incident Location: Quincy, CA				Latitude				N Longitude				W			
Kody Kerwin				<i>Kody Kerwin</i>				Cnty:											
Plumas National Forest Dispatch (530) 283-0193																			

IA GROUP

MEDICAL PLAN (ICS 206 WF) CIIMT 1

1. Incident Name		2. Operational Period					
North Complex		Date/Time: 8/31/2020 24 Hours 0700 - 0700					
3. EMS / Ambulance Services							
Name	Location	Phone	Advanced Life Support (ALS)				
			Yes	No			
Frontline Medical	Quincy ICP	Walk-up	XX				
MEDIC 2	Branch II Day / ICP Night	NIFC C10 NIFC C26	XX				
MEDIC 3	Branch X Day / ICP Night	NIFC C47 NIFC C26 NIFC C10	XX				
Care Flight (Ground)	Quincy & Greenville CA	911 or (530) 283-6300	XX				
4. Air Rescue / Air Ambulance Services							
Name	Phone	Type of Aircraft & Capability					
Care Flight 4	(775) 856-9111	ALS Air Ambulance					
SEMSA Air 1	(775) 856-9111	ALS Air Ambulance					
California National Guard	PNF-ECC – (530) 283-0193	ALS, NVG, Hoist					
5. Hospitals (all times estimated from incident location)							
Name & Level	GPS Datum – WGS 84 Degrees Decimal Minutes		Travel Time Air Gnd		Phone	Helipad Yes No	Address
Plumas District Hospital	Lat:	N 39 56.4115		5 Mins	(530) 283-7110	xx	1065 Bucks Lake Rd Quincy CA
	Long:	W 120 57.715		20 Mins			
Enloe Medical Center Level 2 Trauma Stroke / STEMI	Lat:	N 39° 44.5		30 Mins	(530) 332-7740	xx	1530 Esplanade Chico CA
	Long:	N 121° 51.1		2 Hrs.			
Renown Medical Center Level 2 Trauma Stroke / STEMI	Lat:	N39 31.52		30 Mins	(775) 982-2005	xx	1156 Mill Street Reno NV
	Long:	W119 47.74		1.5 Hrs.			
UC Davis Medical Center Level 1 Trauma Burn	Lat:	N 38° 33.36		45 Mins	(916) 734-5669	xx	2315 Stockton Blvd Sacramento CA
	Long:	W 121° 27.33		3 Hrs.			
6. Division / Crew Emergency Pre-Plan						<i>Update and discuss with assigned resources daily.</i>	
Fireline EMT / Medic's Division / Branch Location							
Air Hoist site location site: Lat: / Long: / Elevation:							
Helispot: Lat: / Long: / Elevation:							
7. Remote Aid Stations		Point of Contact:					
		Equipment Available on Site:	Basic Medical Supplies:				
8. Prepared By (Medical Unit Leader)		9. Date/Time		10. Reviewed By (Safety Officer)		11. Date/Time	
Brian Wisler MEDL 209-620-0660		8/30/2020 1900		Doug McKelvey SOFR1 (510) 453-3817		8/30/20 1900	
							

MEDICAL PLAN (ICS 206 WF) CIIMT 1

1. Incident Name		2. Operational Period					
Sheep Fire		Date/Time: 8/31/2020 24 Hours 0700 - 0700					
3. EMS / Ambulance Services							
Name	Location	Phone		Advanced Life Support (ALS) Yes No			
Medical Unit	Susanville Camp	Walk-up			XX		
MEDIC 1	Branch IV Day/Susanville Camp Night	NIFC C3 NIFC C46		XX			
SEMSA Ambulance	Susanville, CA	SIFC (530) 257-5575		XX			
4. Air Rescue / Air Ambulance Services							
Name	Phone		Type of Aircraft & Capability				
SEMSA Air 1	SIFC (530) 257-5575		ALS Air Ambulance				
Care Flight 4	SIFC (530) 257-5575		ALS Air Ambulance				
CalFire C 202	SIFC (530) 257-5575		Hoist (Day Ops)				
California National Guard	SIFC (530) 257-5575		ALS, NVG, Hoist (24 hours)				
5. Hospitals (all times estimated from incident location)							
Name & Level	GPS Datum – WGS 84 Degrees Decimal Minutes		Travel Time Air Gnd		Phone	Helipad Yes No	Address
Banner Lassen Medical Center	Lat:	N 40 26.250	10	30	(530) 252-2096	xx	1800 Spring Ridge Dr. Susanville CA
	Long:	W 120 37.728	Mins	Mins			
Enloe Medical Center Level 2 Trauma Stroke / STEMI	Lat:	N 39° 44.5	30	2	(530) 332-7740	xx	1530 Esplanade Chico CA
	Long:	N 121° 51.1	Mins	Hrs.			
Renown Medical Center Level 2 Trauma Stroke / STEMI	Lat:	N39 31.52	30	1.5	(775) 982-2005	xx	1156 Mill Street Reno NV
	Long:	W119 47.74	Mins	Hrs.			
UC Davis Medical Center Level 1 Trauma Burn	Lat:	N 38° 33.36	60	4	(916) 734-5669	xx	2315 Stockton Blvd Sacramento CA
	Long:	W 121° 27.33	Mins	Hrs.			
6. Division / Crew Emergency Pre-Plan						<i>Update and discuss with assigned resources daily.</i>	
Fireline EMT / Medic's Division / Branch Location							
Air Hoist site location site: Lat: / Long: / Elevation:							
Helispot: Lat: / Long: / Elevation:							
7. Remote Aid Stations		Point of Contact:					
		Equipment Available on Site: No		Basic Medical Supplies:			
8. Prepared By (Medical Unit Leader)		9. Date/Time		10. Reviewed By (Safety Officer)		11. Date/Time	
Kain Packwood MEDL (209) 678-7448 Brian Wisler MEDL (209) 620-0660		8/30/2020 1900		Doug McKelvey SOFR1 (510) 453-3817		8/30/2020 1900	
							

MEDICAL PLAN (ICS 206 WF) CIIMT 1

Medical Incident Report					
FOR A NON-EMERGENCY INCIDENT, WORK THROUGH CHAIN OF COMMAND TO REPORT AND TRANSPORT INJURED PERSONNEL AS NECESSARY. FOR A MEDICAL EMERGENCY: IDENTIFY ON SCENE INCIDENT COMMANDER BY NAME AND POSITION AND ANNOUNCE "MEDICAL EMERGENCY" TO INITIATE RESPONSE FROM IMT COMMUNICATIONS/DISPATCH.					
Use the following items to communicate situation to communications/dispatch.					
1. CONTACT COMMUNICATIONS / DISPATCH (Verify correct frequency prior to starting report) <i>Ex: "Communications, Div. Alpha. Stand-by for Emergency Traffic."</i>					
2. INCIDENT STATUS: Provide incident summary (including number of patients) and command structure. <i>Ex: "Communications, I have a Red priority patient, unconscious, struck by a falling tree. Requesting air ambulance to Forest Road 1 at (Lat./Long.) This will be the Trout Meadow Medical, IC is TFLD Jones. EMT Smith is providing medical care."</i>					
Severity of Emergency / Transport Priority	<input type="checkbox"/> RED / PRIORITY 1 Life or limb threatening injury or illness. Evacuation need is IMMEDIATE <i>Ex: Unconscious, difficulty breathing, bleeding severely, 2° – 3° burns more than 4 palm sizes, heat stroke, disoriented.</i> <input type="checkbox"/> YELLOW / PRIORITY 2 Serious injury or illness. Evacuation may be DELAYED if necessary. <i>Ex: Significant trauma, unable to walk, 2° – 3° burns not more than 1-3 palm sizes.</i> <input type="checkbox"/> GREEN / PRIORITY 3 Minor injury or illness. Non-Emergency transport <i>Ex: Sprains, strains, minor heat-related illness.</i>				
Nature of Injury or Illness & Mechanism of Injury	Brief Summary of Injury or Illness <i>(Ex: Unconscious, Struck by Falling Tree)</i>				
Transport Request	Air Ambulance / Short Haul/Hoist Ground Ambulance / Other				
Patient Location	Descriptive Location & Lat. / Long. <i>(WGS84)</i>				
Incident Name	Geographic Name + "Medical" <i>(Ex: Trout Meadow Medical)</i>				
On-Scene Incident Commander	Name of on-scene IC of Incident within an Incident <i>(Ex: TFLD Jones)</i>				
Patient Care	Name of Care Provider <i>(Ex: EMT Smith)</i>				
3. INITIAL PATIENT ASSESSMENT: Complete this section for each patient as applicable (start with the most severe patient)					
Patient Assessment: See IRPG PAGE 106					
Treatment:					
4. TRANSPORT PLAN:					
Evacuation Location (if different): <i>(Descriptive Location (drop point, intersection, etc.) or Lat. / Long.)</i> Patient's ETA to Evacuation Location:					
Helispot / Extraction Site Size and Hazards:					
5. ADDITIONAL RESOURCES / EQUIPMENT NEEDS:					
<i>Example: Paramedic/EMT, Crews, Immobilization Devices, AED, Oxygen, Trauma Bag, IV/Fluid(s), Splints, Rope rescue, Wheeled litter, HAZMAT, Extrication</i>					
6. COMMUNICATIONS: Identify State Air/Ground EMS Frequencies and Hospital Contacts as applicable					
Function	Channel Name/Number	Receive (RX)	Tone/NAC *	Transmit (TX)	Tone/NAC *
COMMAND					
AIR-TO-GRND					
TACTICAL					
7. CONTINGENCY: <u>Considerations:</u> If primary options fail, what actions can be implemented in conjunction with primary evacuation method? Be thinking ahead.					
8. ADDITIONAL INFORMATION: Updates/Changes, et c.					
REMEMBER: Confirm ETA's of resources ordered. Act according to your level of training. Be Alert. Keep Calm. Think Clearly. Act Decisively.					

Daily requirement of all personnel assigned to the North Complex & Sheep Fire

Region 5: Employee Self-Assessment Questions

June 11, 2020

Have all employees apply this self-assessment prior to entering any work location every day. This self-assessment includes four questions:

1. In the last 14 days have you had a fever, shortness of breath, body-aches or coughing (not attributable to something else, e.g. allergies) or been diagnosed with COVID-19 (presumptive or positive test)?
 - If so, do not return to work until cleared by a medical professional or you meet CDC guidance on "Discontinuation of Isolation."
2. In the last 14 days have you had close contact with someone who may have COVID-19? This includes anyone with a positive COVID-19 test or who has COVID-19 symptoms (fever, shortness of breath, body-aches or coughing (not attributable to allergies)).
 - If so, you cannot report to the workplace until cleared by a medical provider or until 14 days after the last date of exposure. If you develop symptoms, see #1.
3. In the last 14 days have you assisted in the care of an individual (outside your household) who is not well?
 - If so and you were wearing proper PPE (including a N95 mask), work with your supervisor to determine whether you should report to the workplace.
 - If so and you were not wearing proper PPE, you cannot report to the workplace until cleared by a medical provider or until 14 days after date of exposure. If you develop symptoms, see #1.
4. In the last 14 days have you traveled outside your local area?
 - If so, you should notify your supervisor and monitor yourself for symptoms for 14 days. If mitigations were not possible during travel, work with your supervisory chain to determine if self-quarantine is needed. If you develop symptoms, see #1.



Local Government Resources on CFAA

If you are demobing from an incident and there is no OES AREP on site
F-42 thru the Incident Finance Section Chief or the Incident Commander
One of them must sign your 42's

The Incident keeps the Pink copy and you keep the Golden.
The Original and Green you mail to OES Headquarters as per the
instructions on the front of your F-42

OES JOB AIDS, FORMS, F-42 SAMPLES AND CFAA AGREEMENT



Your OES AREP for the North Complex including the Sheep

Patrick Titus
916-634-9225

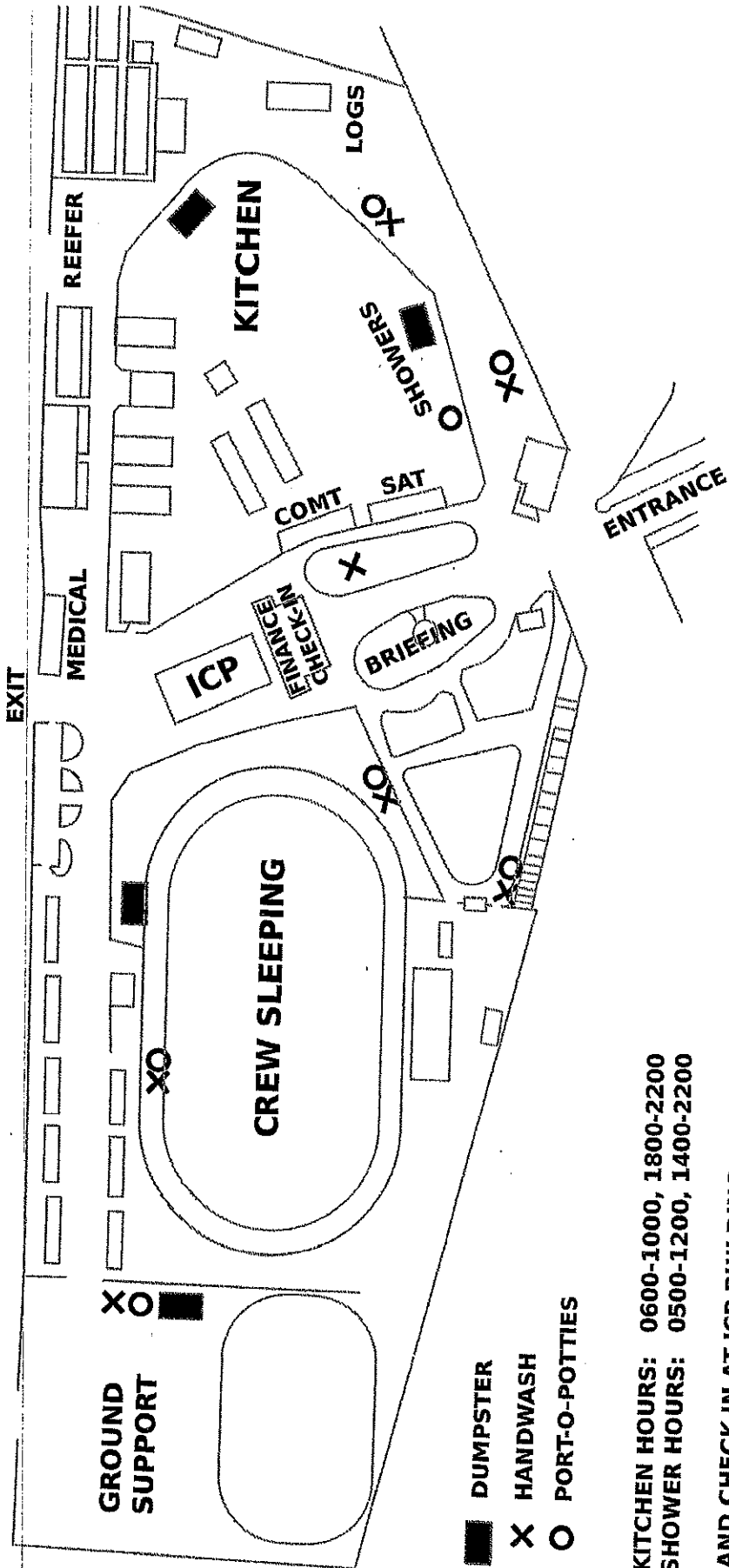

WATER SOURCE USE LOG

DATE: _____ INCIDENT: _____

DIVISION/GROUP: _____

WATER TENDER VENDER OR AGENCY ID: _____

RESOURCE ORDER REQUEST #:

WATER SOURCE LOCATION	HYDRANT	OPEN SOURCE (i.e. pond, creek)	TANK	GALLONS USED	PROPERTY OWNER/CONTACT INFORMATION

TURN INTO FINANCE EQUIPMENT TIME DAILY

Please note if you made contact with property owner and get their contact information. This document is intended to track, record, and validate the amount of water used on an incident. It is not intended to review the performance of equipment using water on an incident.

