

ELDORADO
OR972S-000942
Div A
August 22, 2015, Day
NAD 83
Approx 20,611 ac

Incident Action
Plan Map

Page 2 of 12

Legend

 Potential Fire Spread

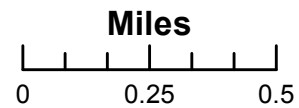
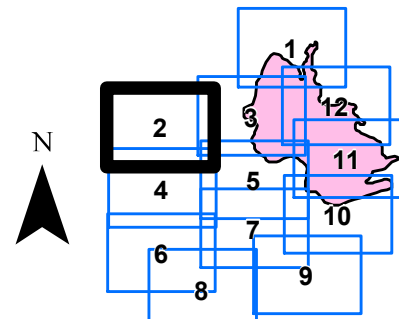

ODF GIS, Team 3
August 21, 2015
2231 Hours

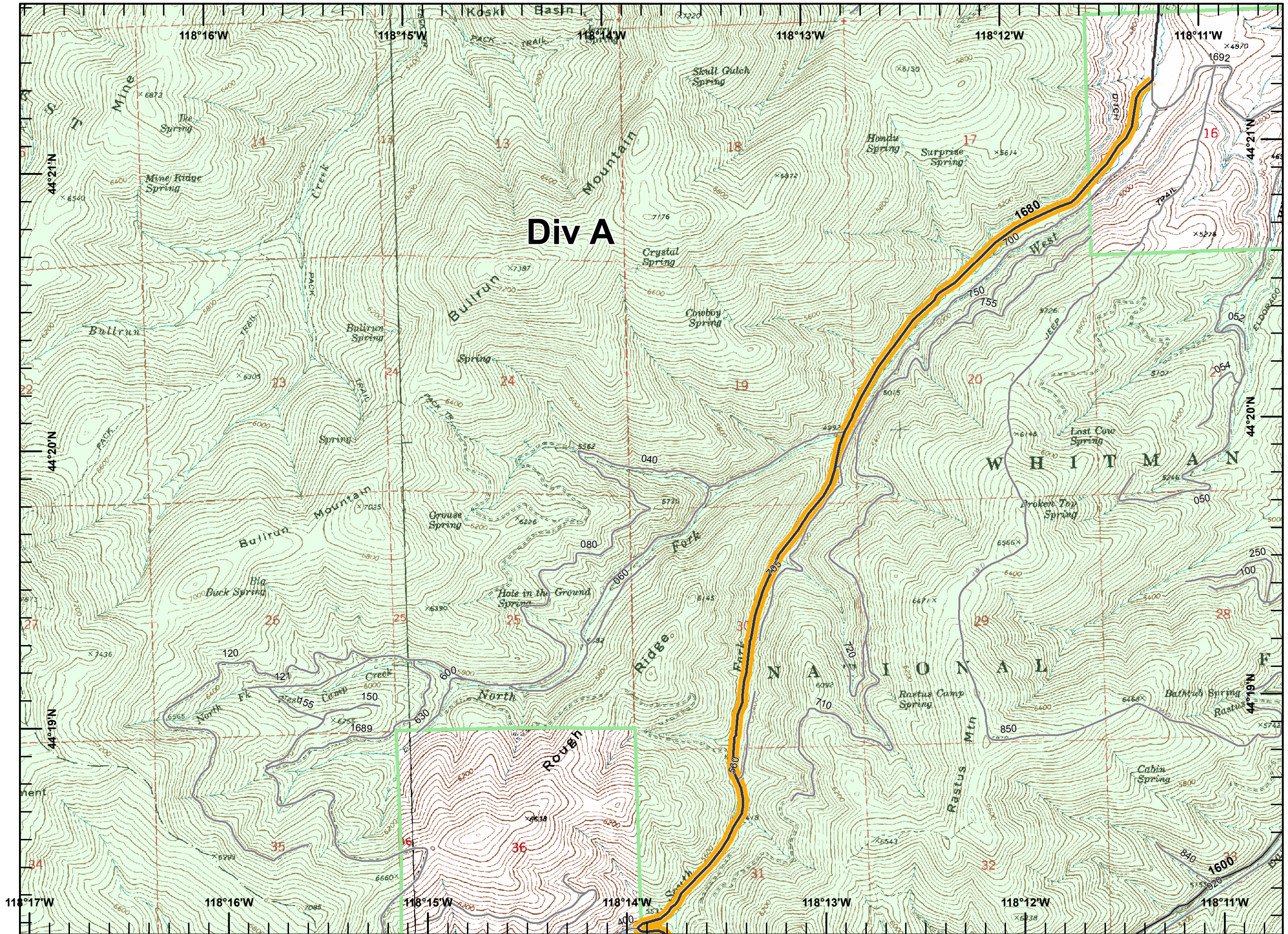

Page 4

ELDORADO
OR972S-000942

Div A

August 22, 2015, Day

NAD 83

Approx 20,611 ac

Incident Action Plan Map

Page 4 of 12

Legend

 Potential Fire Spread

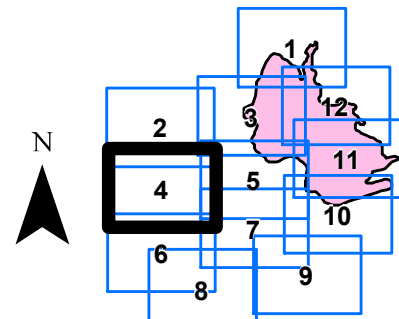

Miles

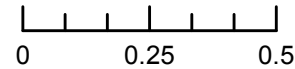

ODF GIS, Team 3
August 21, 2015
2231 Hours

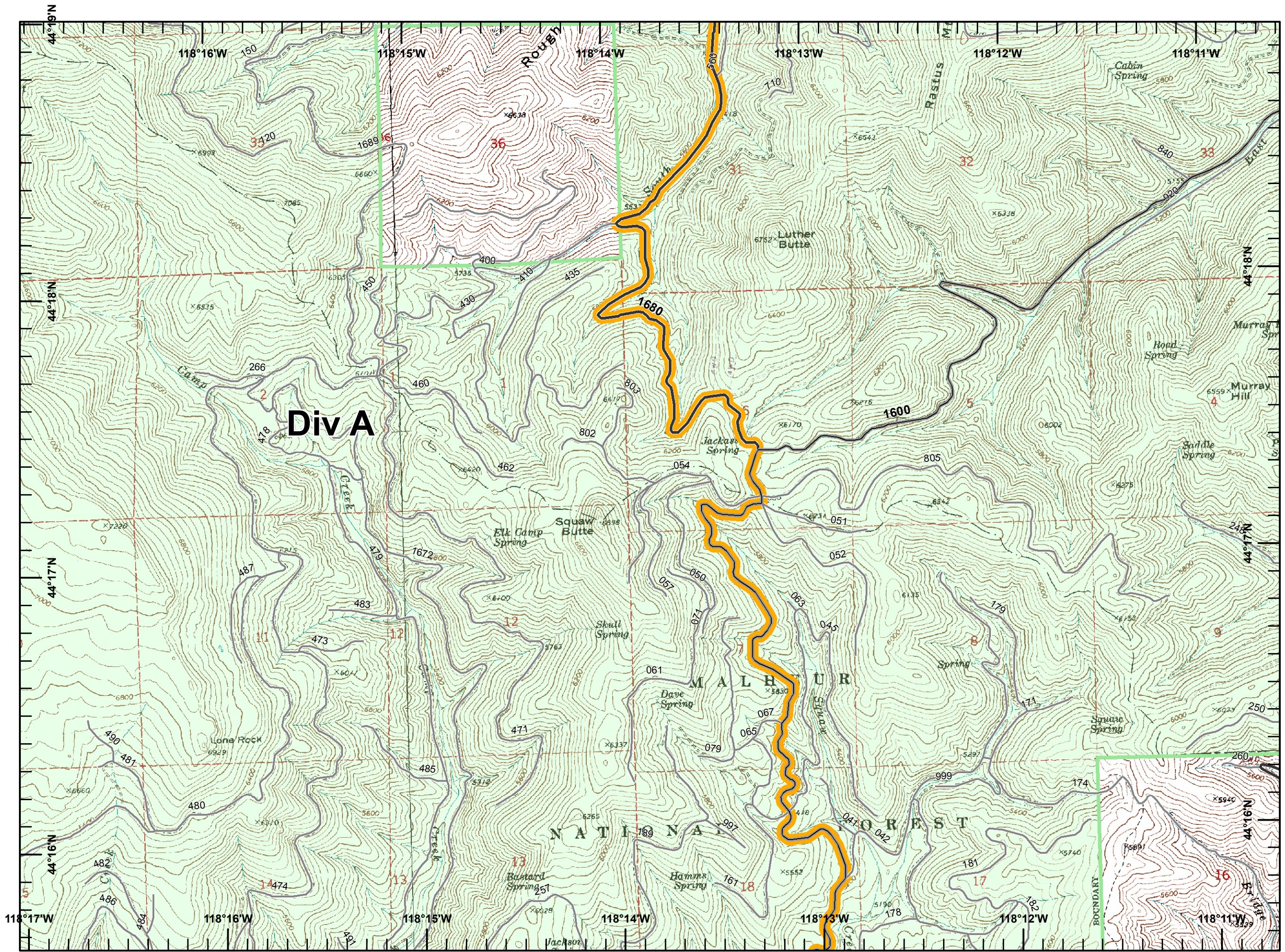









Page 5

ELDORADO
OR972S-000942
Div M-R-W
August 22, 2015, Day
NAD 83
Approx 20,611 ac

Incident Action Plan Map

Page 5 of 12

Legend

-  Uncontrolled Fire Edge
-  Completed Dozer Line
-  Hand Line
-  Road as Completed Line
-  Drop Point
-  MediVac Site
-  Pump
-  Safety Zone
-  Structures

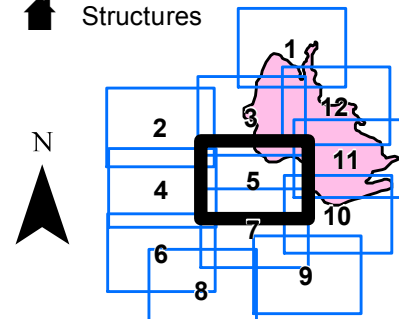

Miles

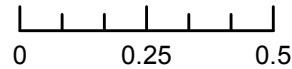

ODF GIS, Team 3
August 21, 2015
2232 Hours

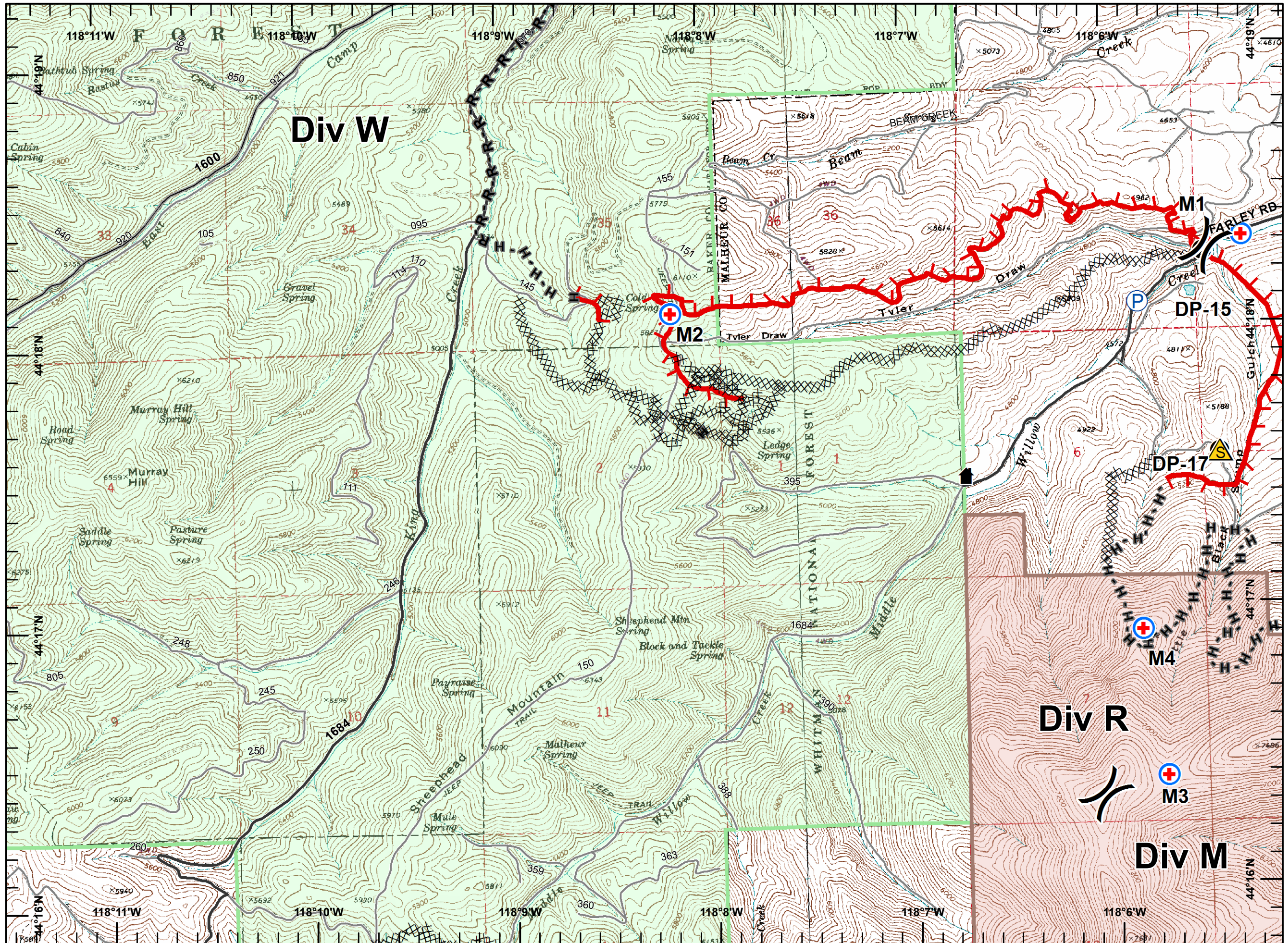

Page 6

ELDORADO
OR972S-000942

Div W

August 22, 2015, Day

NAD 83

Approx 20,611 ac

Incident Action Plan Map

Page 6 of 12

Legend

 Potential Fire Spread

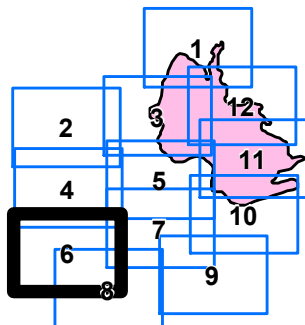
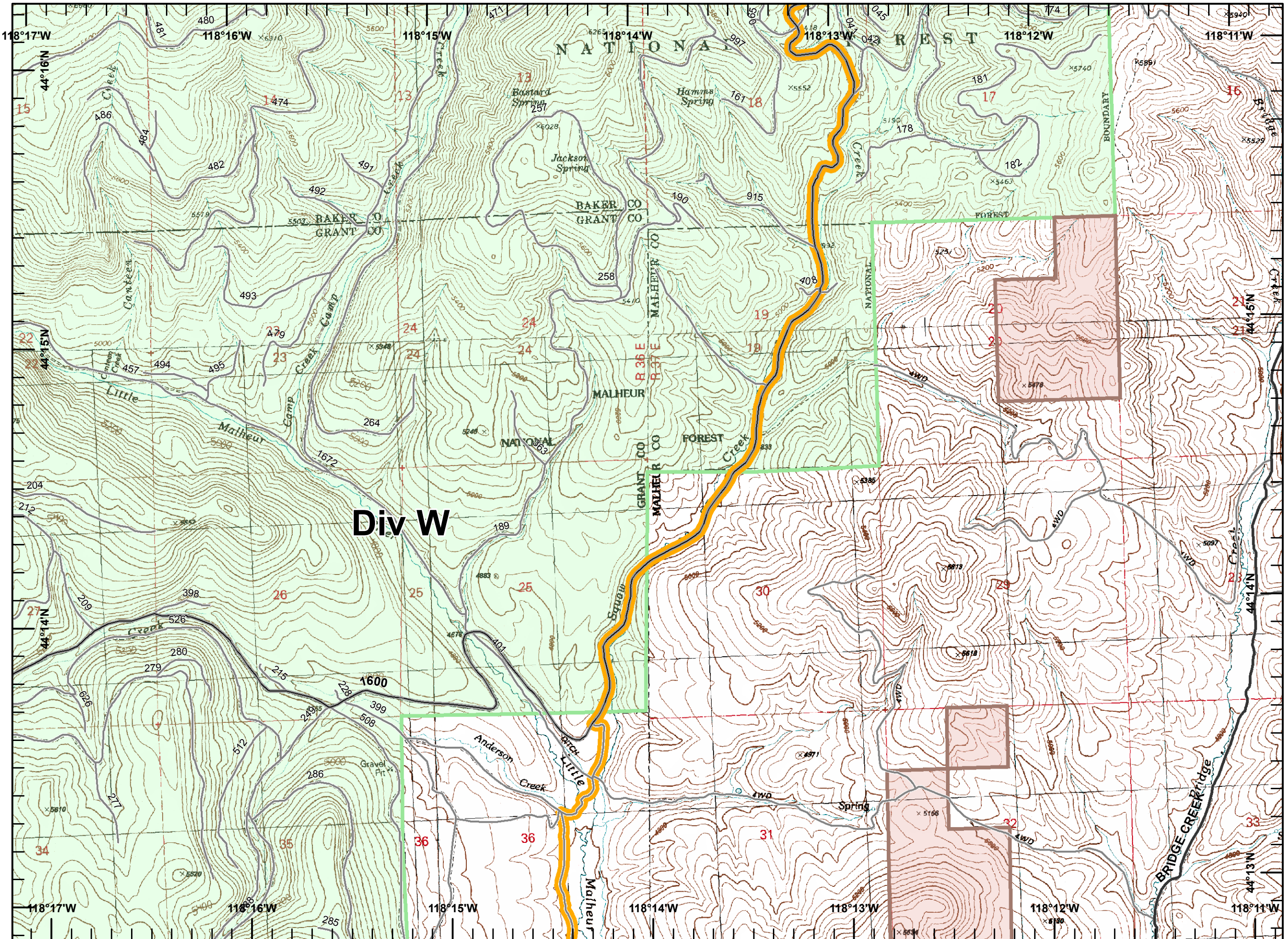

Miles

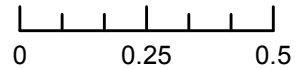

ODF GIS, Team 3
August 21, 2015
2232 Hours

Page 7

ELDORADO
OR972S-000942

Div M-R

August 22, 2015, Day

NAD 83

Approx 20,611 ac

Incident Action Plan Map

Page 7 of 12

Legend

XXXXX Completed Dozer Line

H - H Hand Line

⊕ MediVac Site

Ⓡ Repeater

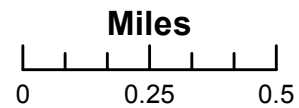
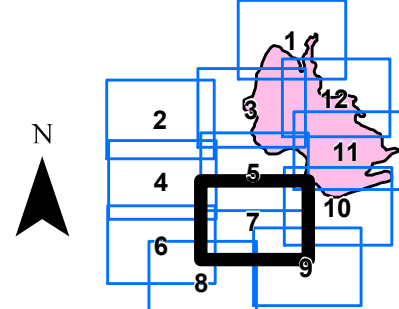

ODF GIS, Team 3
August 21, 2015
2232 Hours

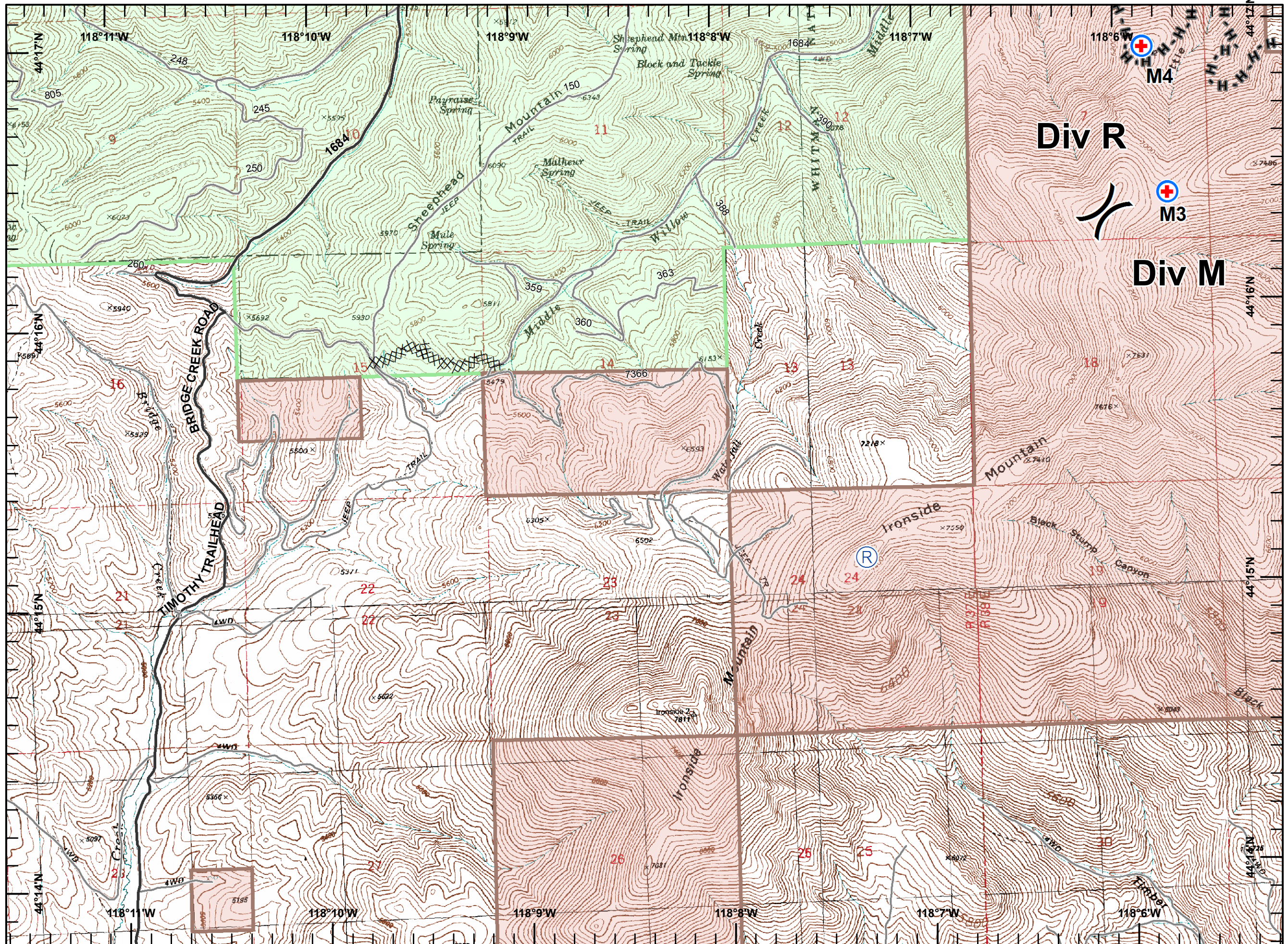

Page 8

ELDORADO
OR972S-000942
Div M-R-W
August 22, 2015, Day
NAD 83
Approx 20,611 ac

Incident Action Plan Map

Page 8 of 12

Legend

 Potential Fire Spread

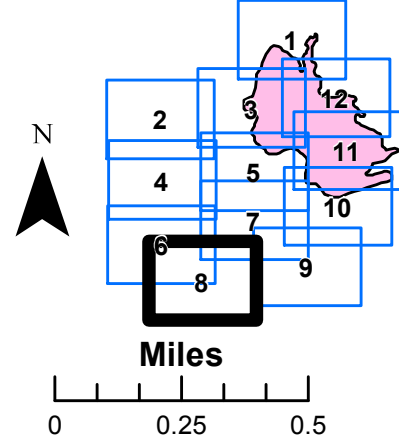

ODF GIS, Team 3
August 21, 2015
2232 Hours

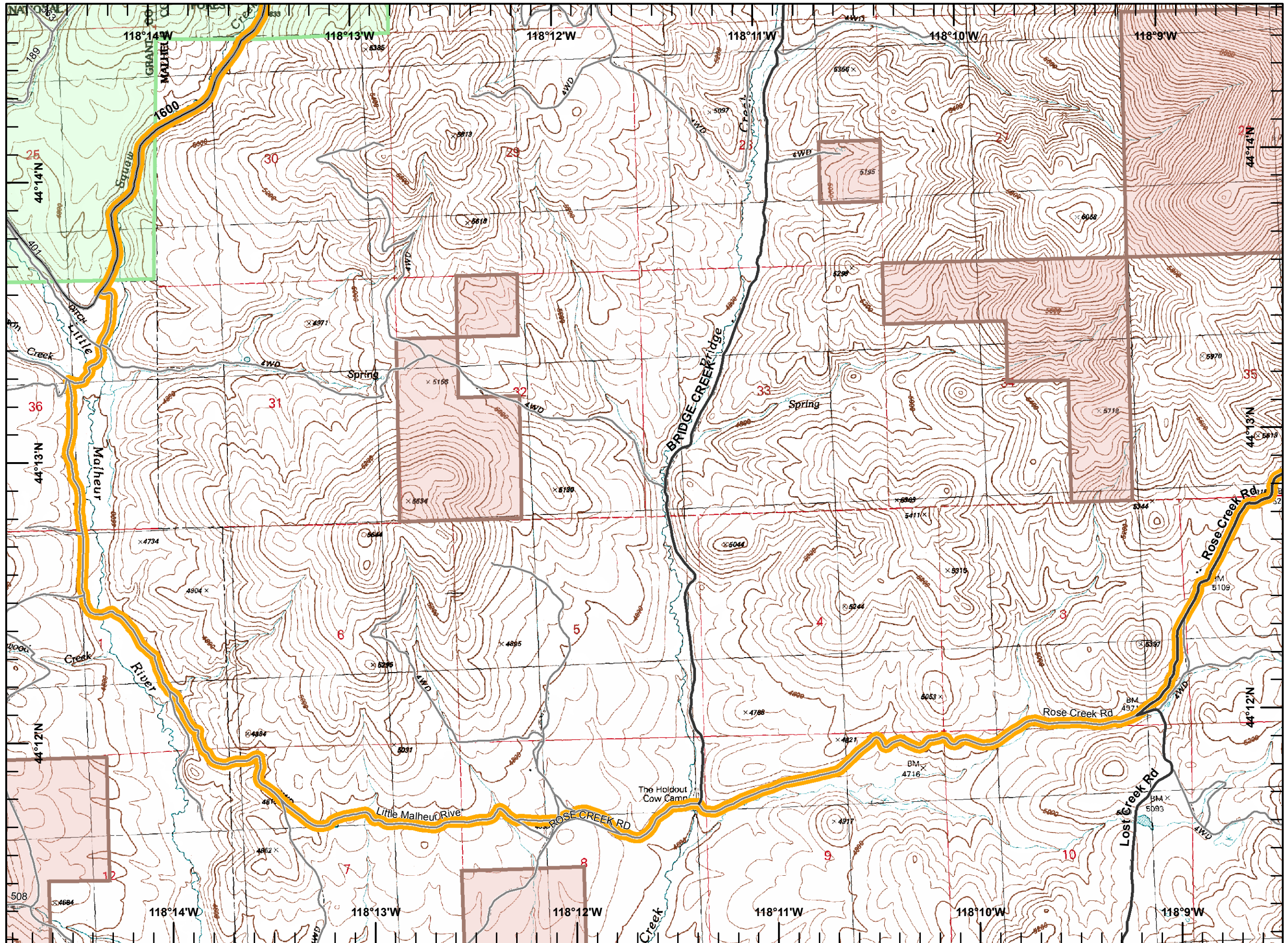



Page 9

ELDORADO
OR972S-000942
Div M
August 22, 2015, Day
NAD 83
Approx 20,611 ac

Incident Action Plan Map

Page 9 of 12

Legend

-  Potential Fire Spread
-  Repeater
-  Structures

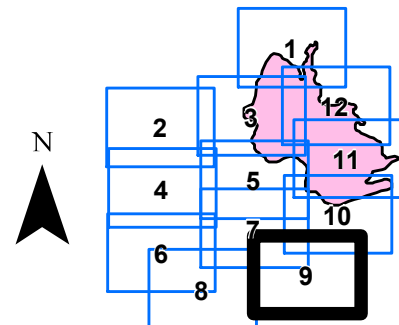

Miles

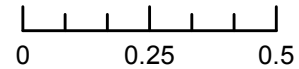

ODF GIS, Team 3
August 21, 2015
2232 Hours

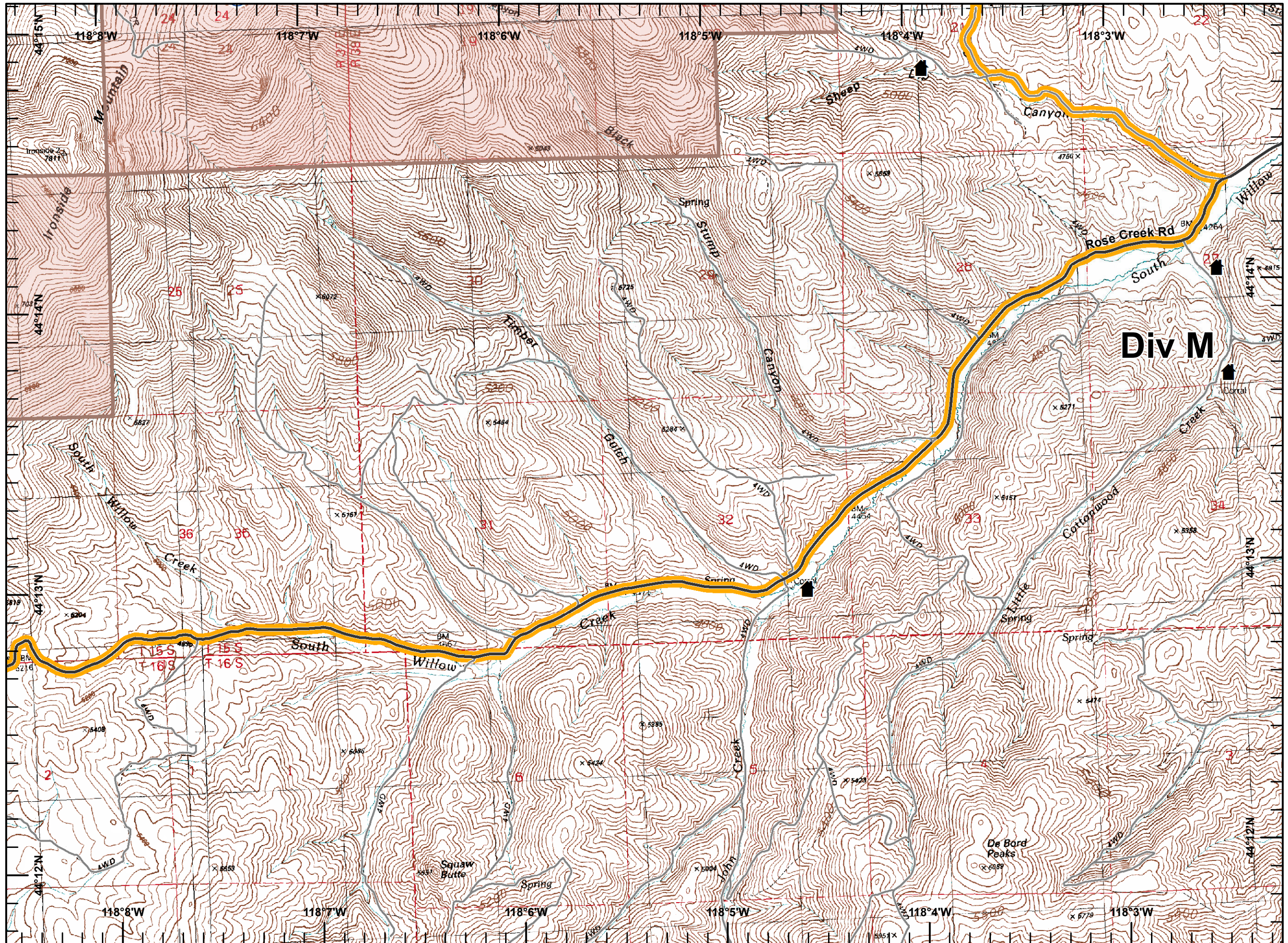









ELDORADO
OR972S-000942
Div M-R
August 22, 2015, Day
NAD 83
Approx 20,611 ac

Incident Action
Plan Map

Page 10 of 12

Legend

-  Uncontrolled Fire Edge
-  Completed Dozer Line
-  Completed Line
-  Hand Line
-  Potential Fire Spread
-  Drop Point
-  MediVac Site
-  Safety Zone
-  Structures

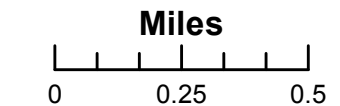
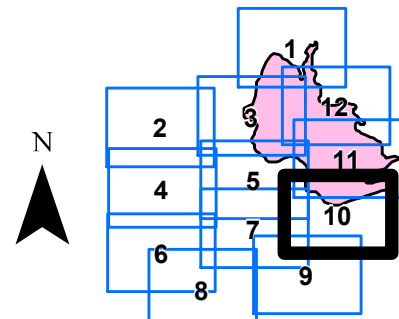

ODF GIS, Team 3
August 21, 2015
2233 Hours

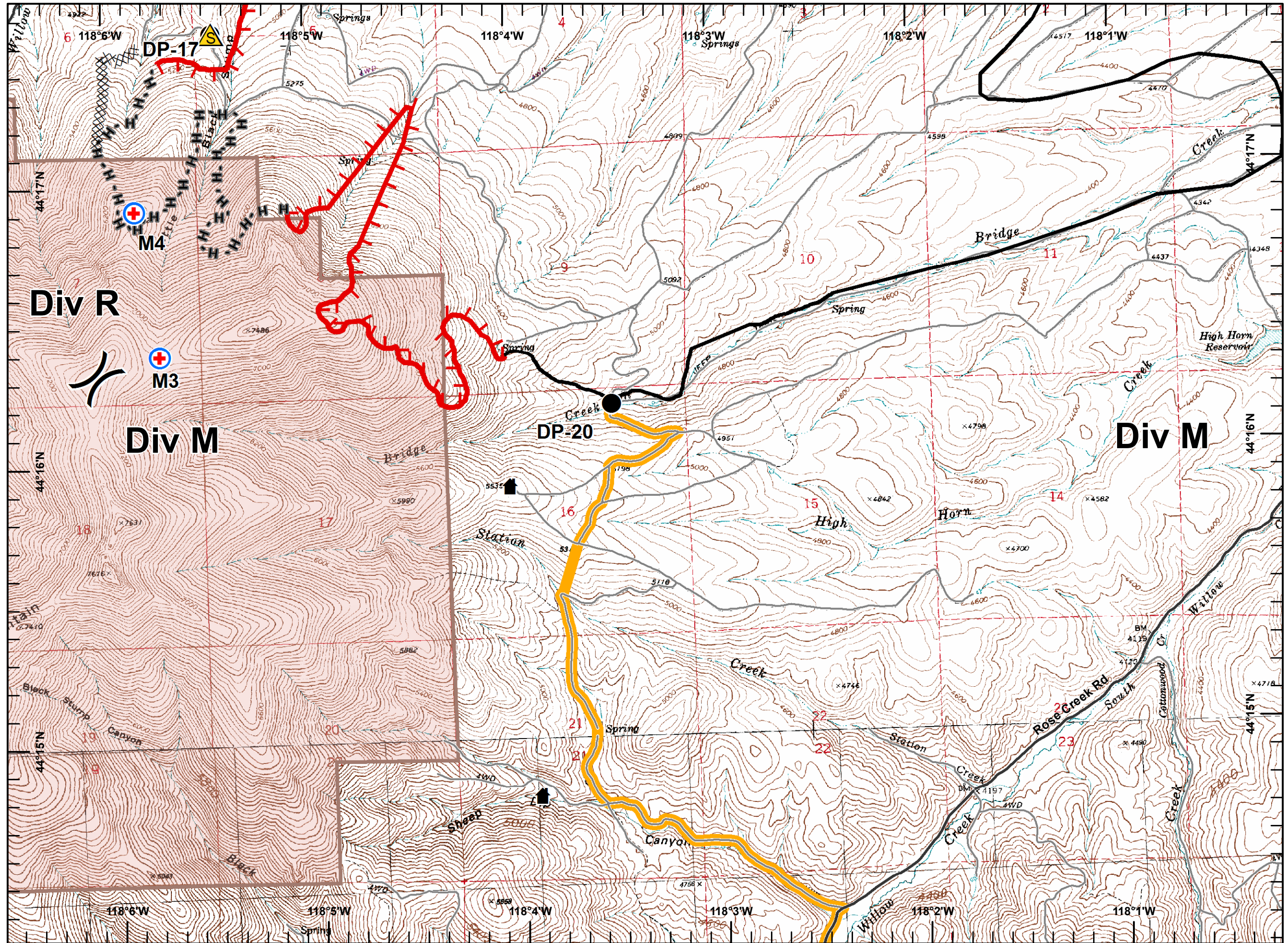

Incident Action Plan Map

Page 11 of 12

Legend

Uncontrolled Fire Edge

Completed Dozer Line

Completed Line

Hand Line

Drop Point

MediVac Site

Pump

Safety Zone

Dip Site

Structures

N



Miles

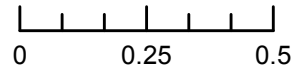

ODF GIS, Team 3
August 21, 2015
2233 Hours

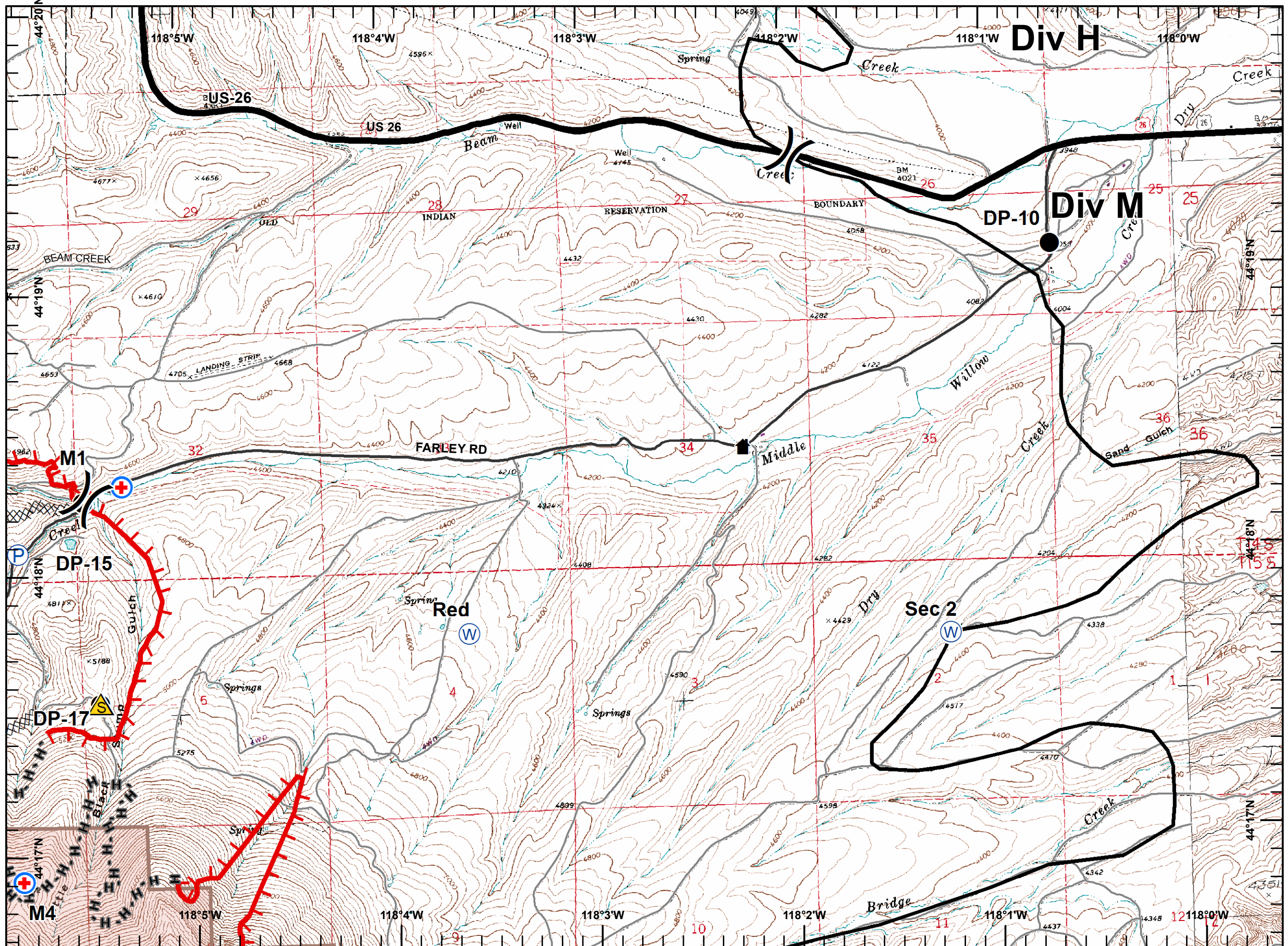

ELDORADO
OR972S-000942

Div H-M

August 22, 2015, Day

NAD 83

Approx 20,611 ac

Incident Action Plan Map

Page 12 of 12

Legend

- Completed Line
- Drop Point
- Ⓜ Dip Site

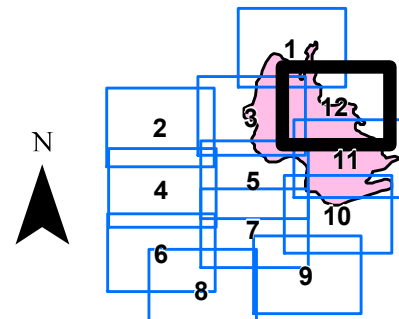

Miles

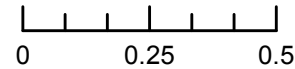

ODF GIS, Team 3
August 21, 2015
2233 Hours

