

IAP
Green Ridge
OR-UMF-000659

8/3/21

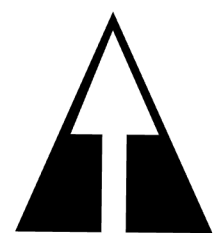

- Incident Command Post
- Completed Dozer Line
- Completed Fuel Break
- Completed Hand Line
- Completed Mixed Construction Line
- Completed Road as Line
- Planned Dozer Line
- Planned Fuel Break
- Planned Hand Line
- Planned Road as Line
- Highlighted Feature
- Other
- Repair Line
- Fire Edge
- Contained Line
- Wildfire Daily Fire Perimeter

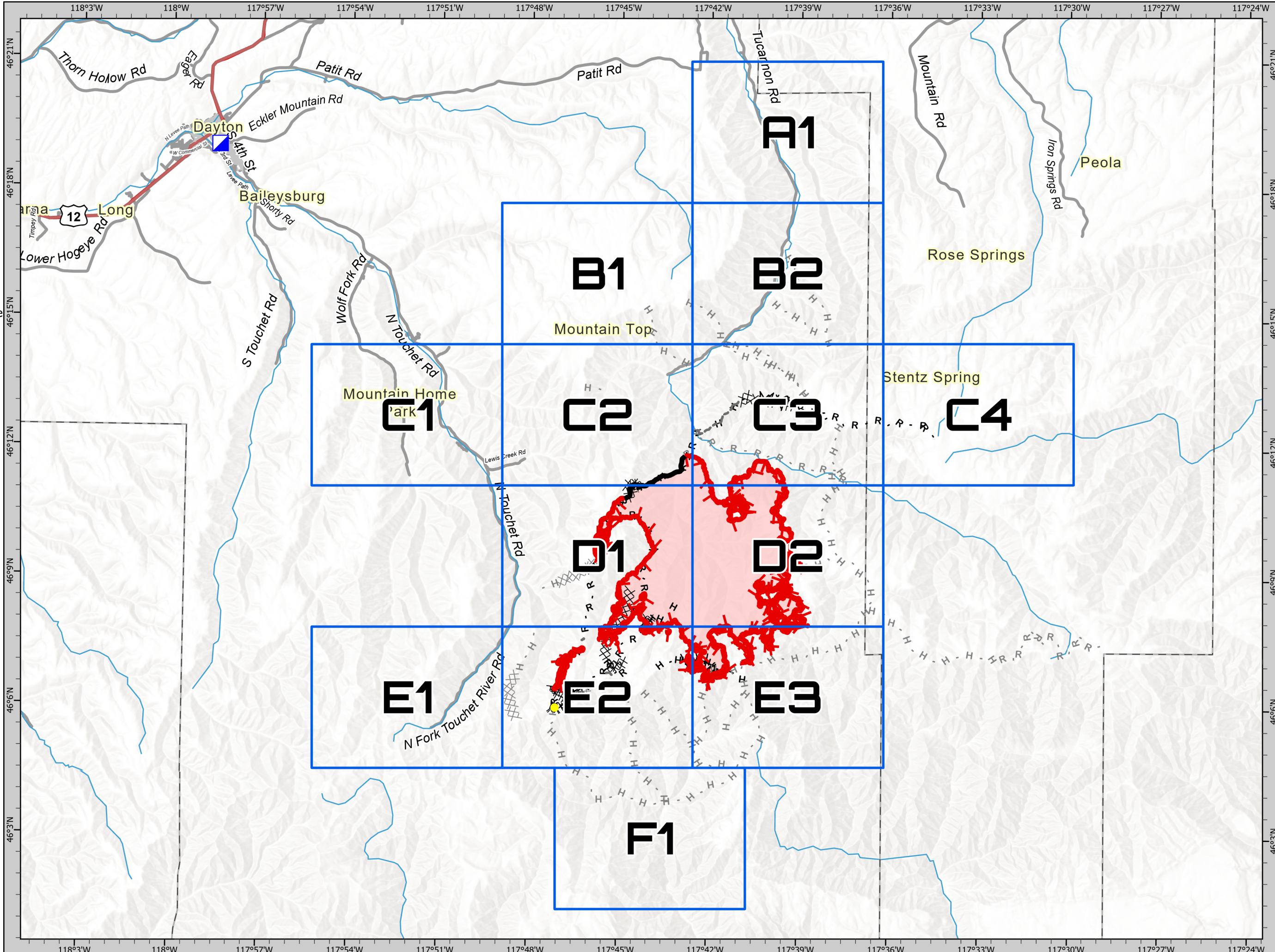

1:150,000 NAD83 UTM 11N



IAP
Green Ridge
OR-UMF-000659

8/3/21



- Helispot
- ▲ Camp
- Ⓜ Repeater

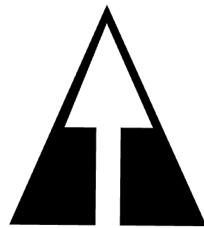
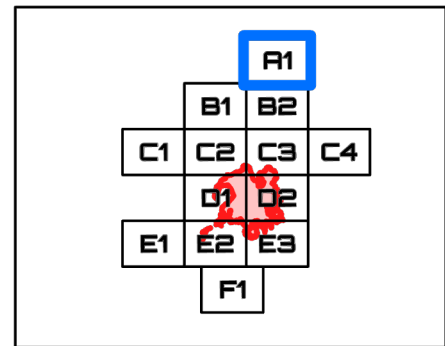

1:25,000 NAD83 UTM 11N

0 1,000 2,000 4,000 Feet

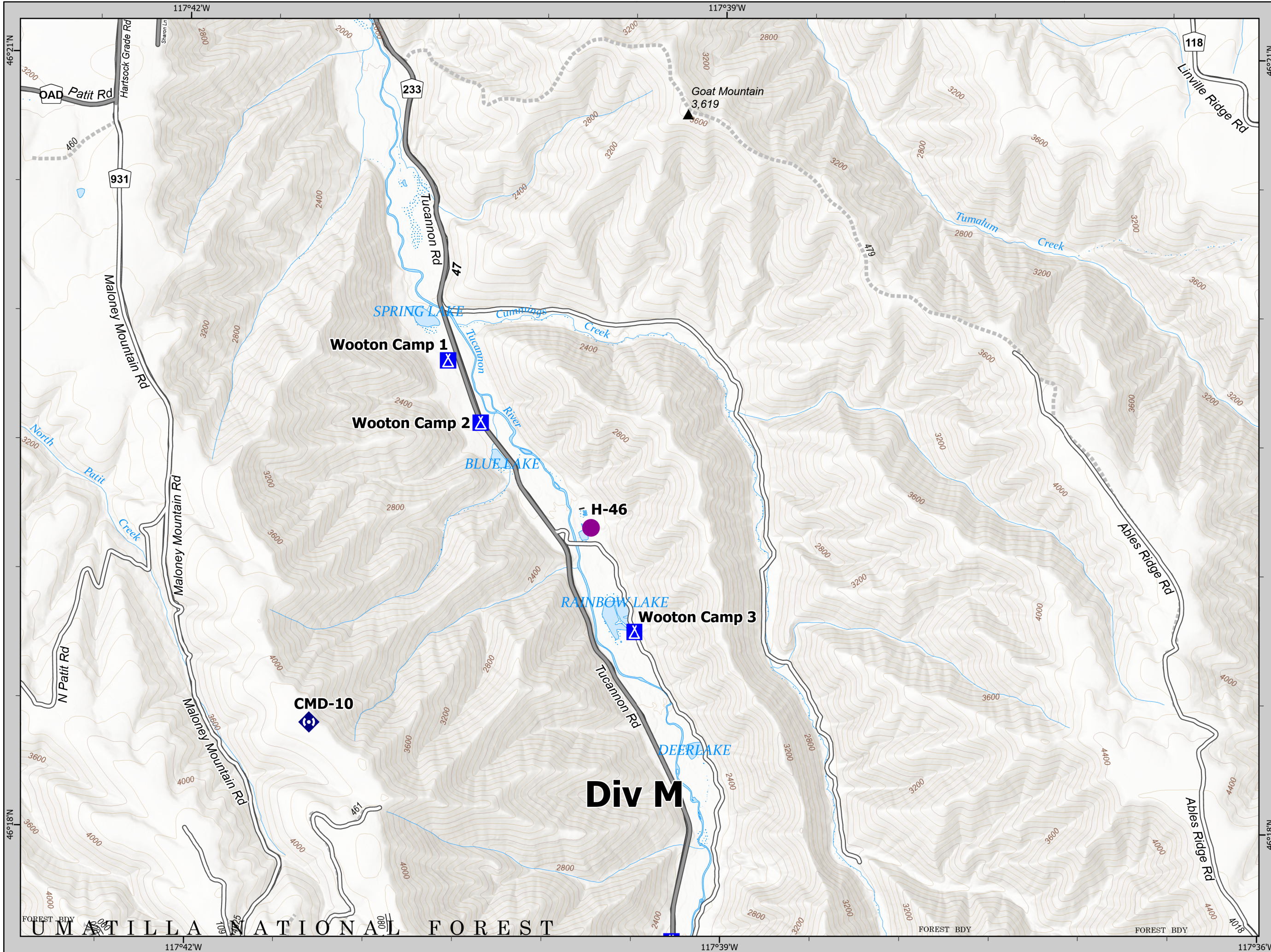

IAP
Green Ridge
OR-UMF-000659

8/3/21



H - Planned Hand Line

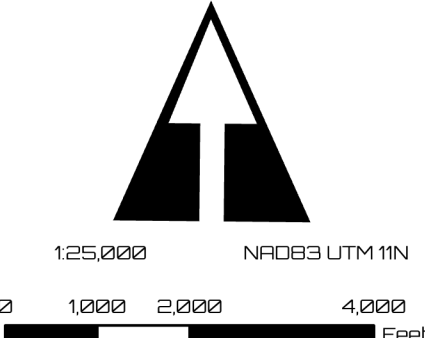
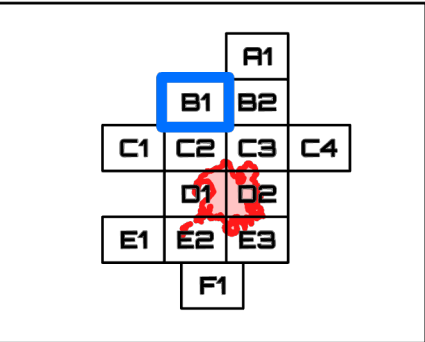
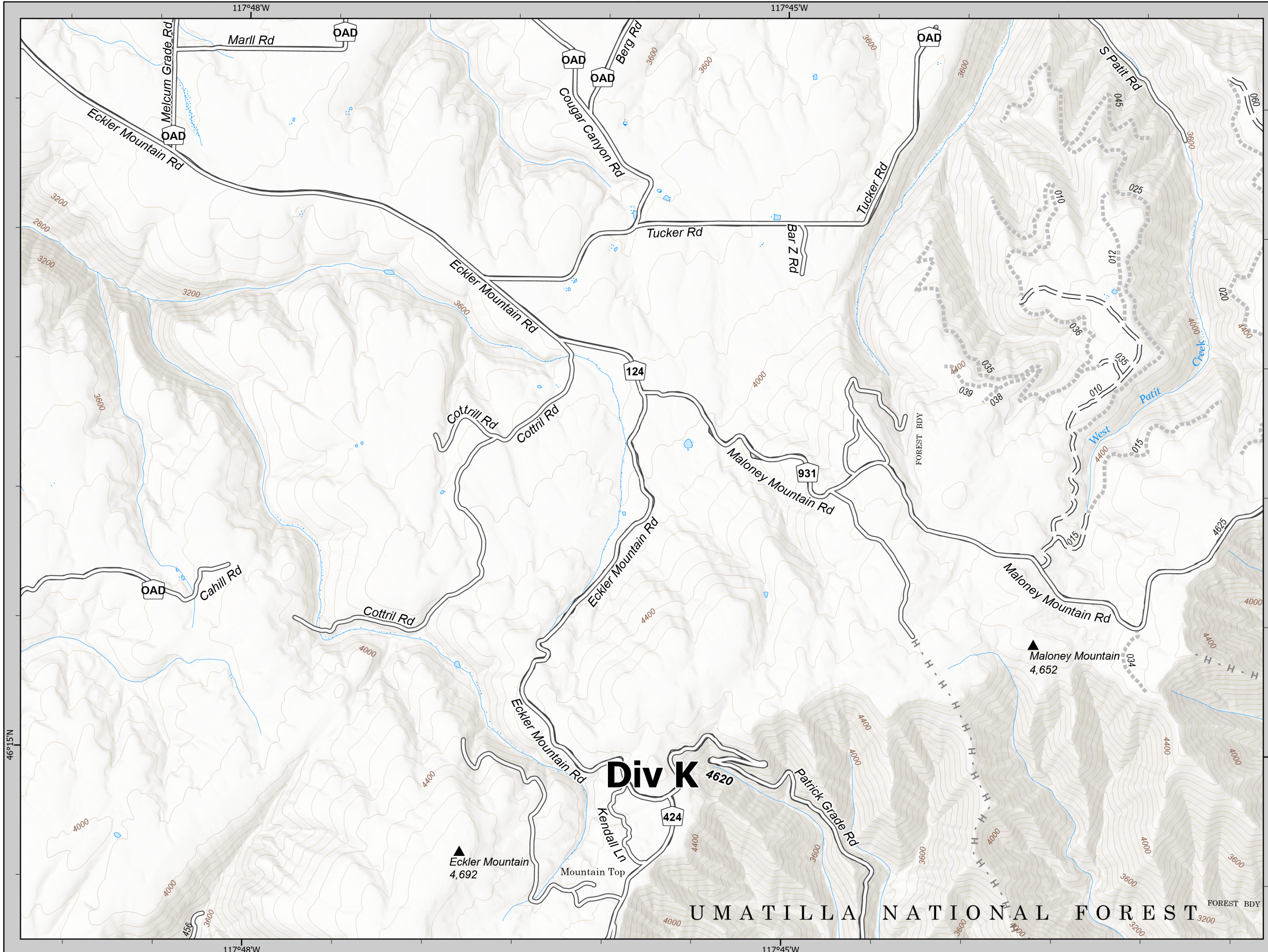

IAP
Green Ridge
OR-UMF-000659

8/3/21



- Drop Point
- ⊗ Camp
- ⊙ Water Source
- H - Planned Hand Line

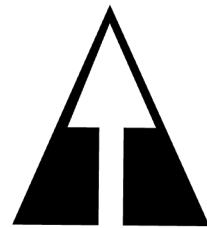
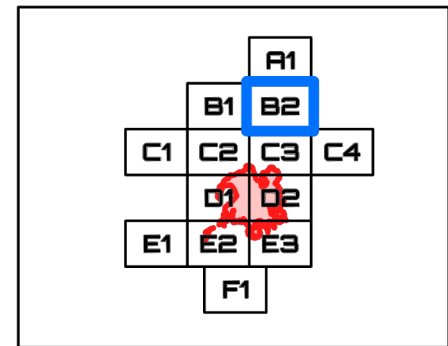

1:25,000 NAD83 UTM 11N



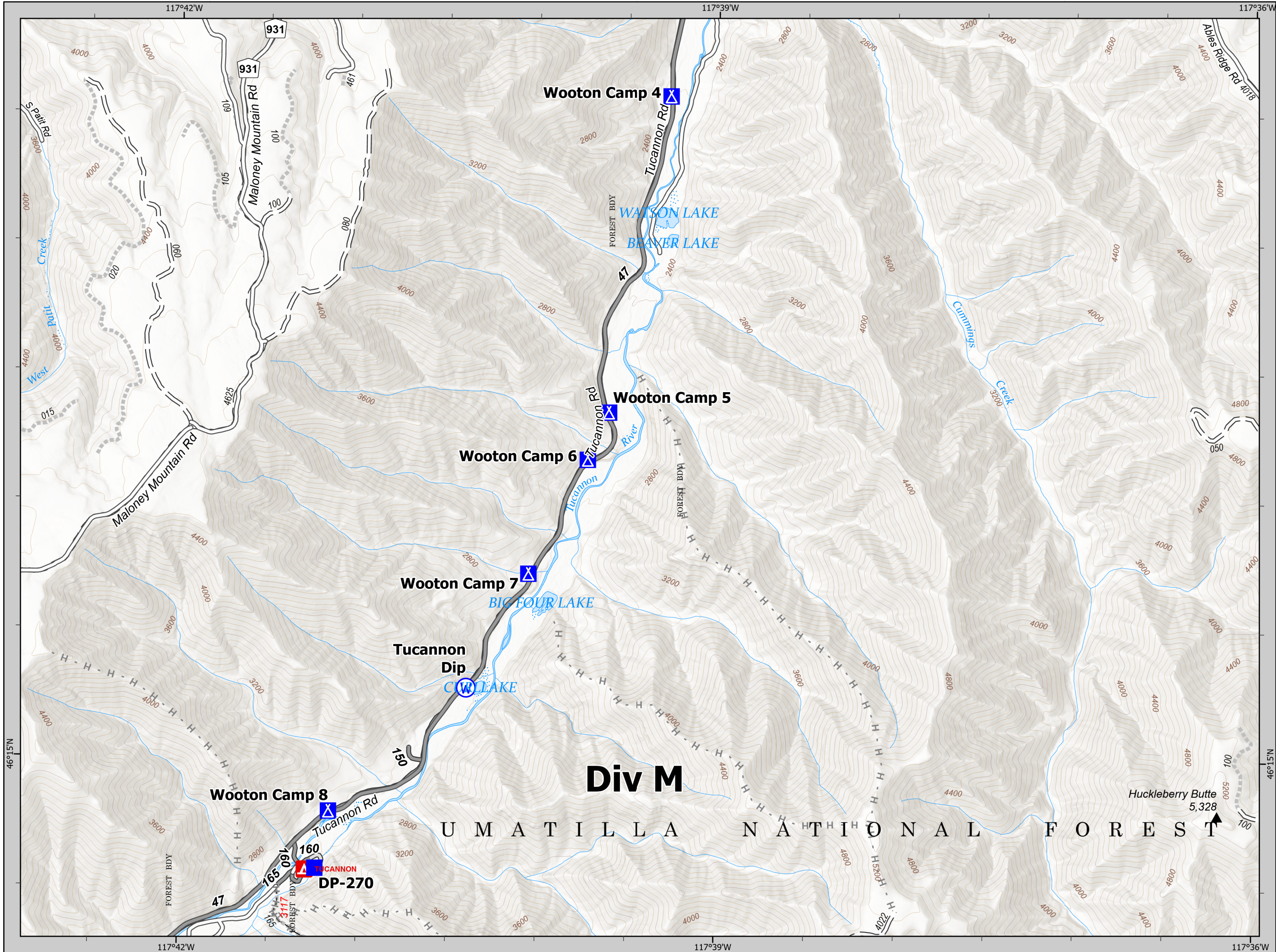

0 1,000 2,000 4,000 Feet



IAP
Green Ridge
OR-UMF-000659

8/3/21



-  Dip Site
-  Value at Risk
-  Gate
-  Bridge

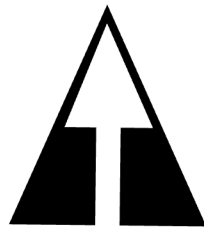
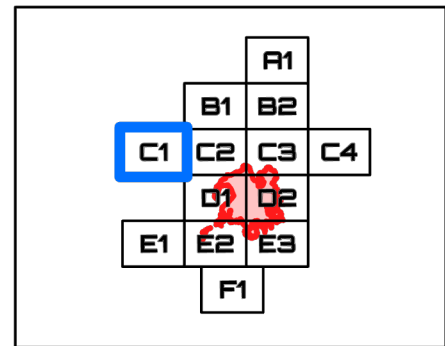

1:25,000 NAD83 UTM 11N

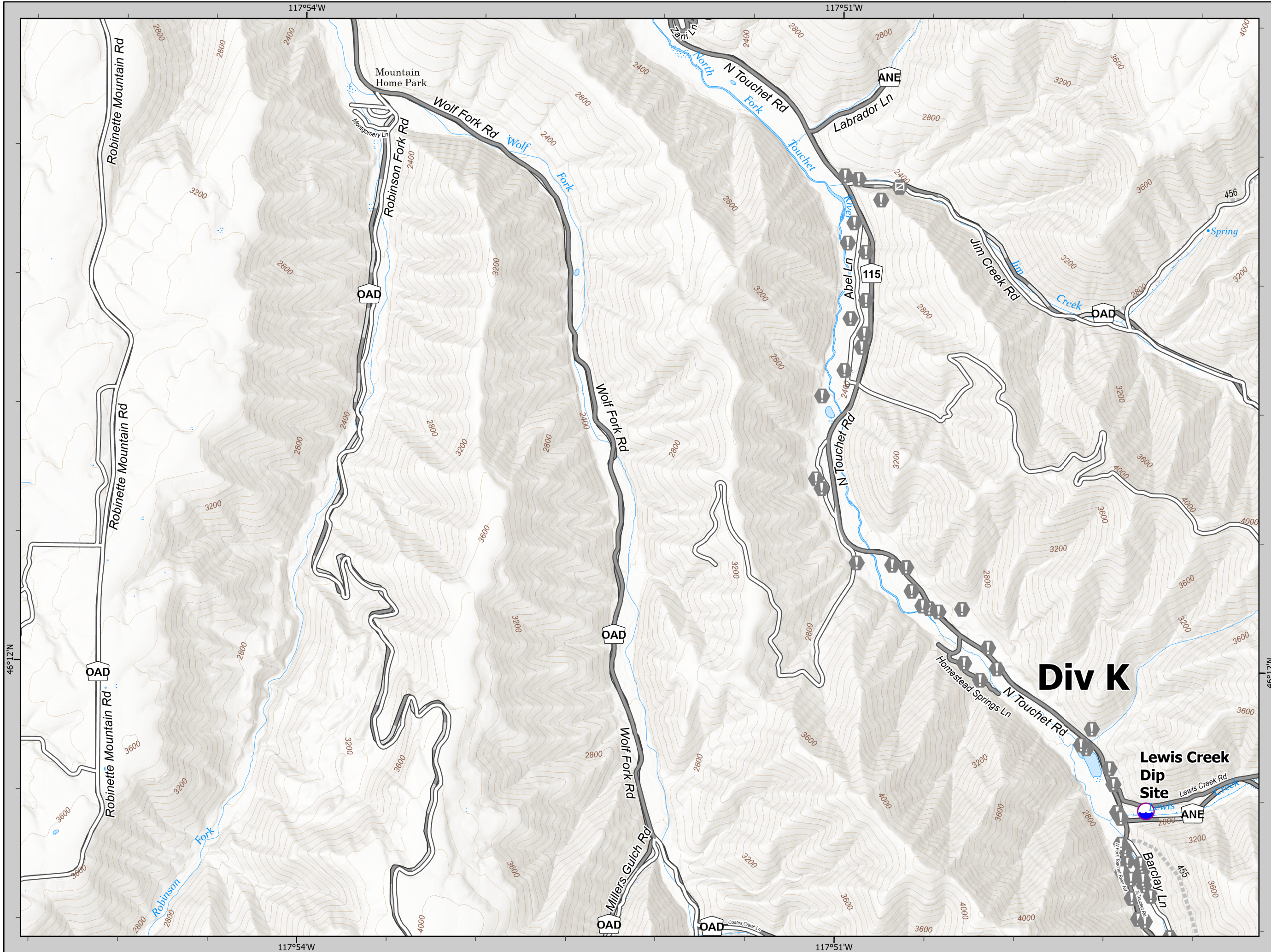
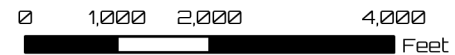

IAP
Green Ridge
OR-UMF-000659

8/3/21



- Dip Site
- Helispot
- Sling Site
- Division Break
- Drop Point
- Camp
- Value at Risk
- Repair Point
- Mobile Weather Unit
- Repeater
- Completed Dozer Line
- Completed Hand Line
- Completed Road as Line
- Planned Hand Line
- Planned Road as Line
- Other
- Fire Edge
- Contained Line
- Wildfire Daily Fire Perimeter

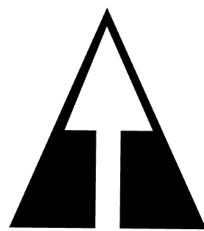
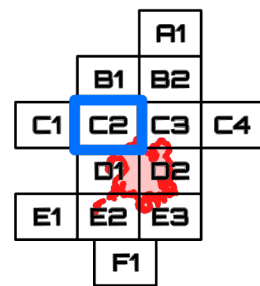

1:25,000 NAD83 UTM 11N

0 1,000 2,000 4,000 Feet

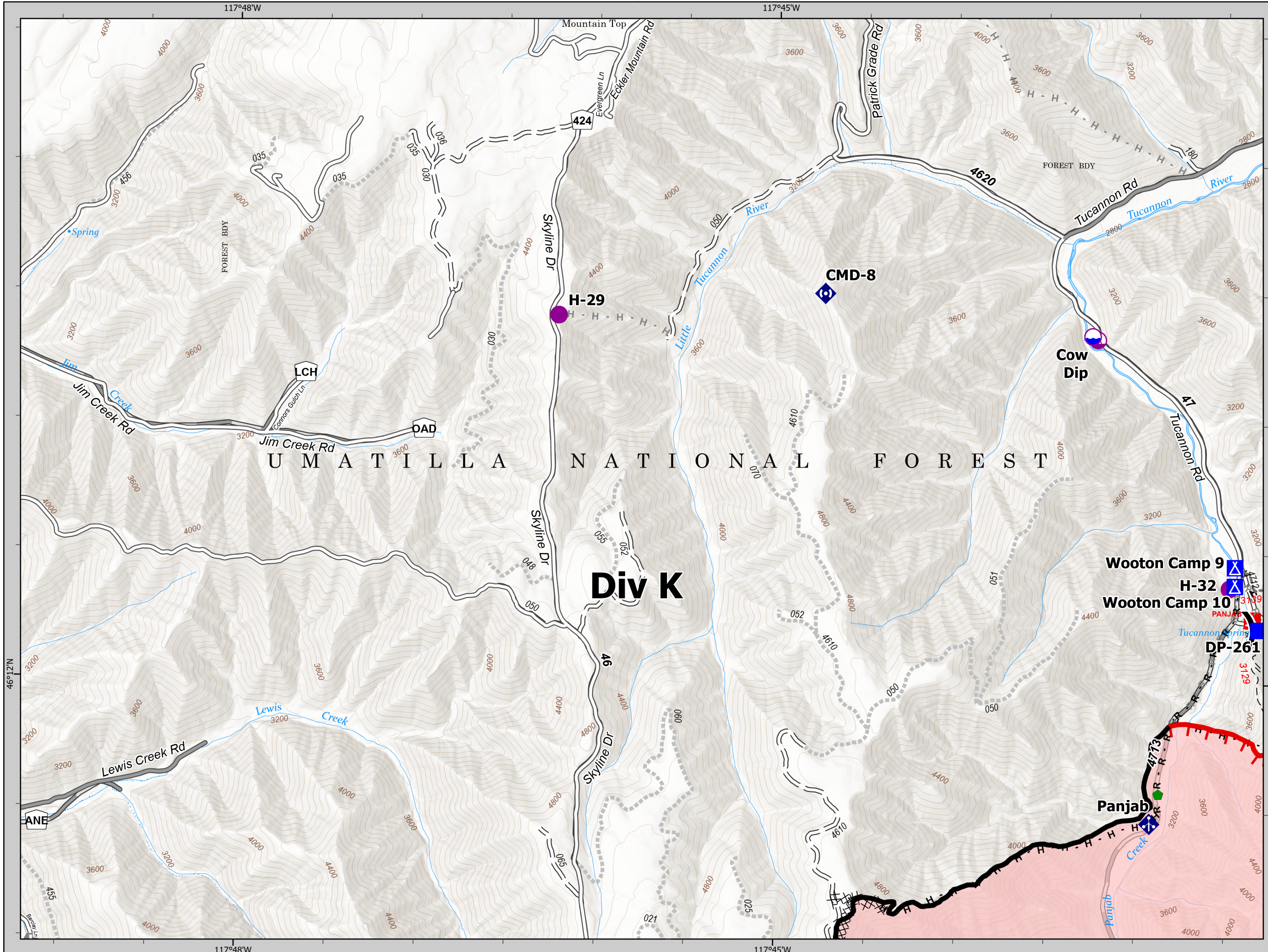

IAP
Green Ridge
OR-UMF-000659

8/3/21



- Helispot
- ⊕ Sling Site
- ⌋ Division Break
- Drop Point
- ⊠ Camp
- ⚠ Value at Risk
- ⚠ Road Repair
- ⚠ Resource Location
- ⚠ Repair Point
- ⚠ Landing or Log Deck
- ⚠ Dozer Push
- ⚠ Mobile Weather Unit
- ⌘ Completed Dozer Line
- ⌘ Completed Fuel Break
- H - Completed Hand Line
- R - Completed Road as Line
- H - Planned Hand Line
- R - Planned Road as Line
- Other
- Repair Line
- Fire Edge
- Contained Line
- Wildfire Daily Fire Perimeter

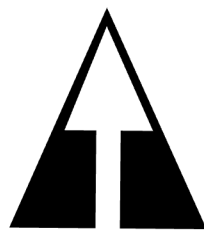
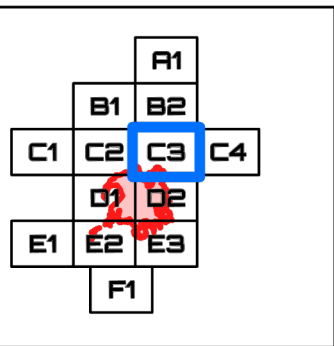

1:25,000 NAD83 UTM 11N

0 1,000 2,000 4,000 Feet

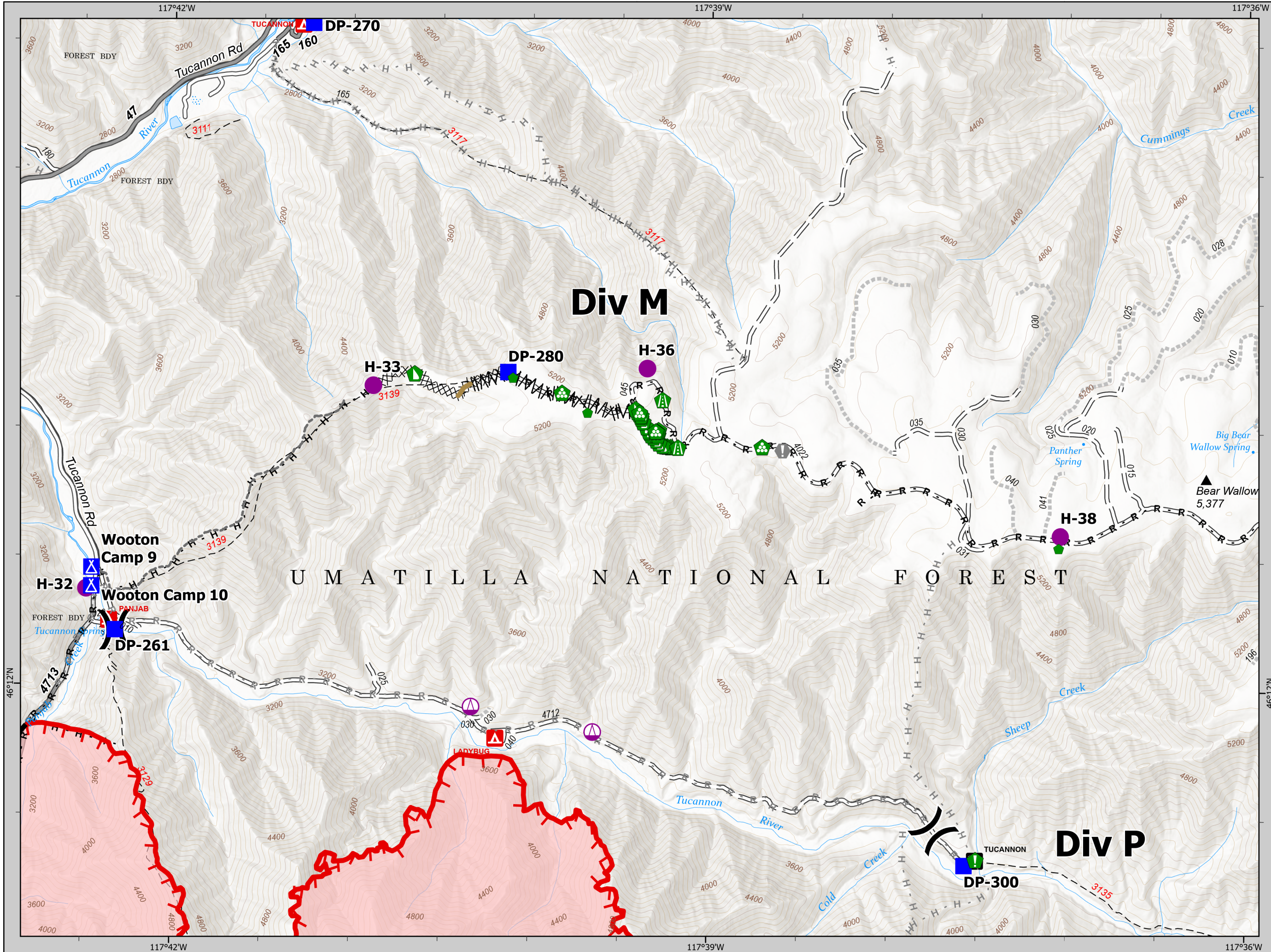

IAP
Green Ridge
OR-UMF-000659

8/3/21



- Helispot
- Drop Point
- Stream Crossing
- Repair Point
- R - Completed Road as Line

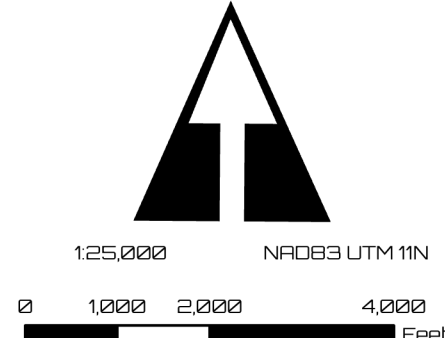
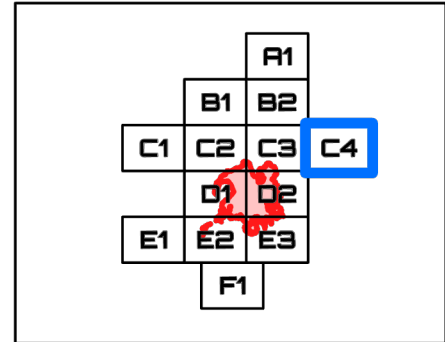
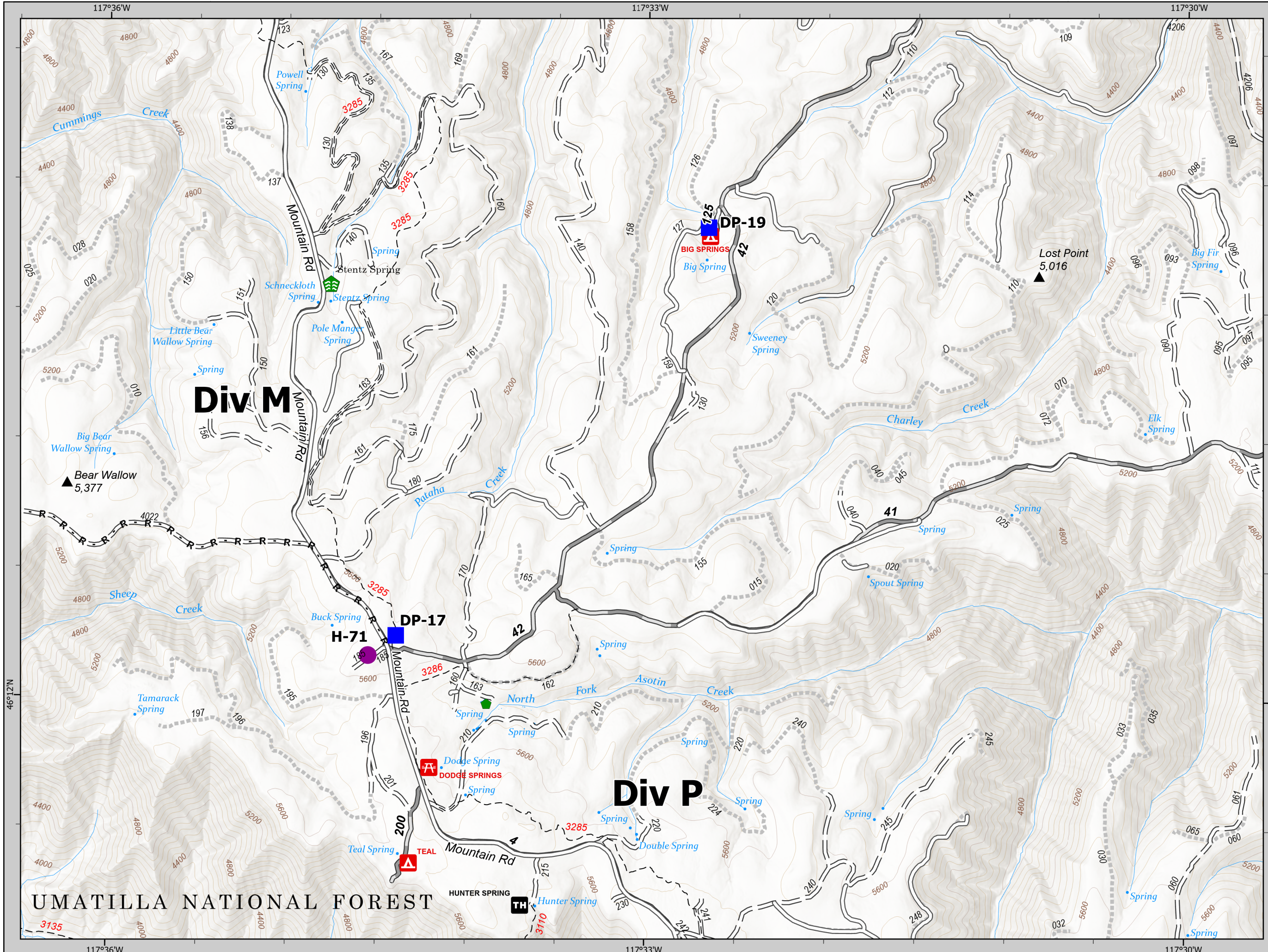

8/3/21



- Helispot
- Sling Site
- Division Break
- Drop Point
- Camp
- Lookout
- Value at Risk
- Resource Location
- Repair Point
- Landing or Log Deck
- Water Source
- Completed Dozer Line
- Completed Hand Line
- Completed Road as Line
- Planned Dozer Line
- Planned Hand Line
- Fire Edge
- Contained Line
- Wildfire Daily Fire Perimeter

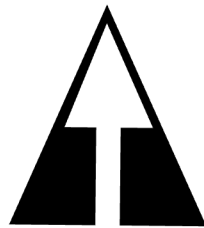
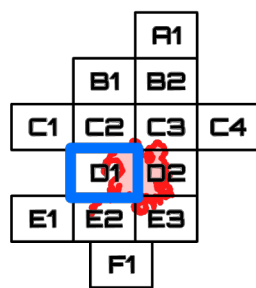

1:25,000 NAD83 UTM 11N

0 1,000 2,000 4,000 Feet

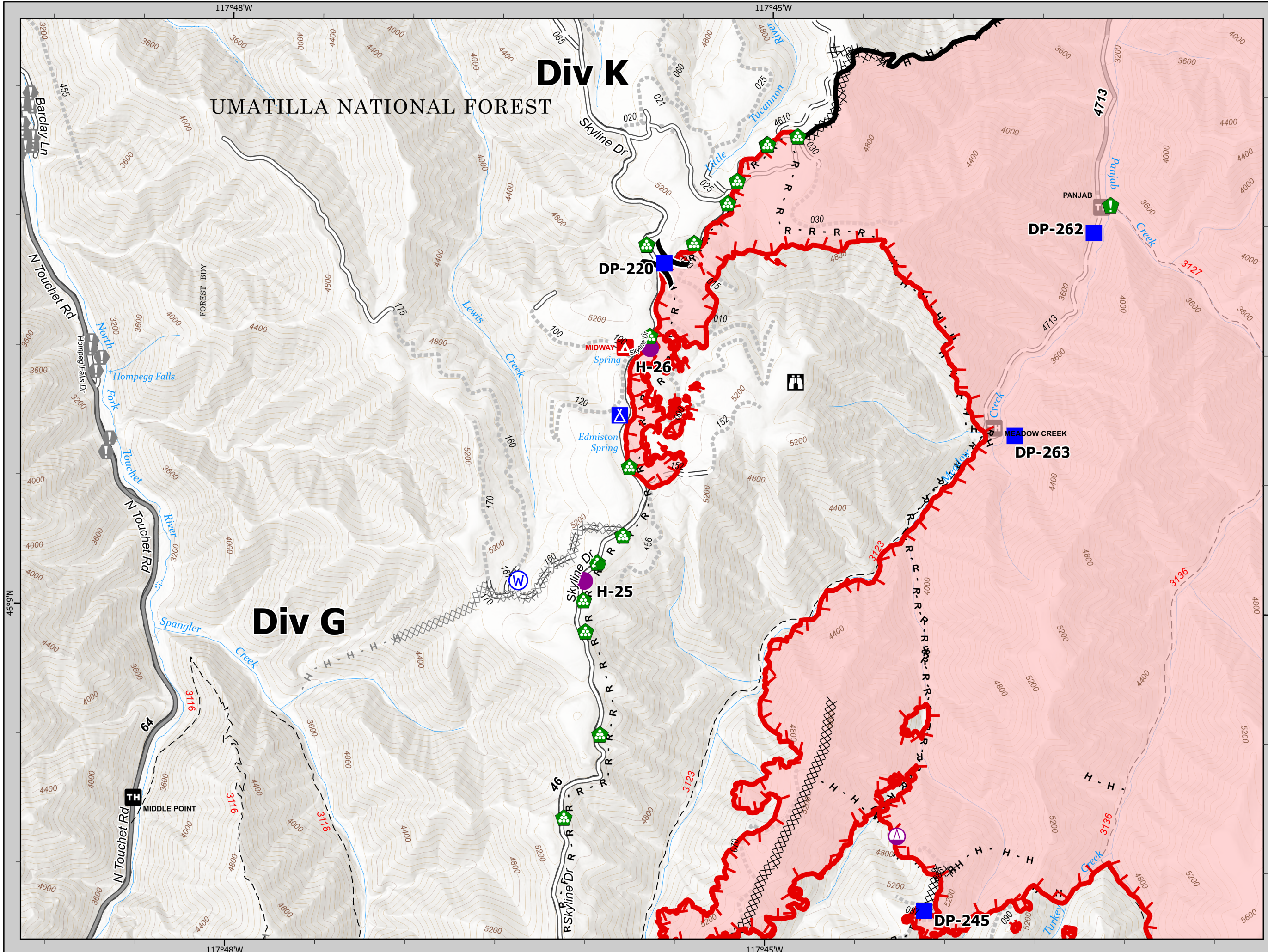

IAP
Green Ridge
OR-UMF-000659

8/3/21



- Helispot
- Division Break
- Drop Point
- Resource Location
- H - Planned Hand Line
- R - Planned Road as Line
- Fire Edge
- Wildfire Daily Fire Perimeter

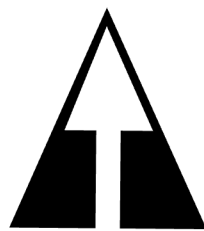
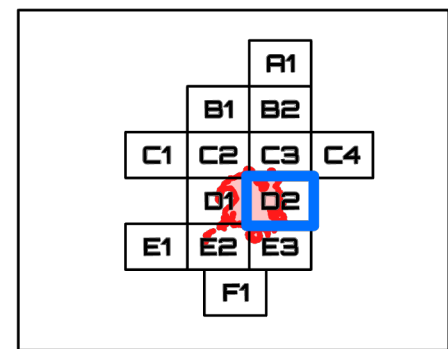

1:25,000 NAD83 UTM 11N



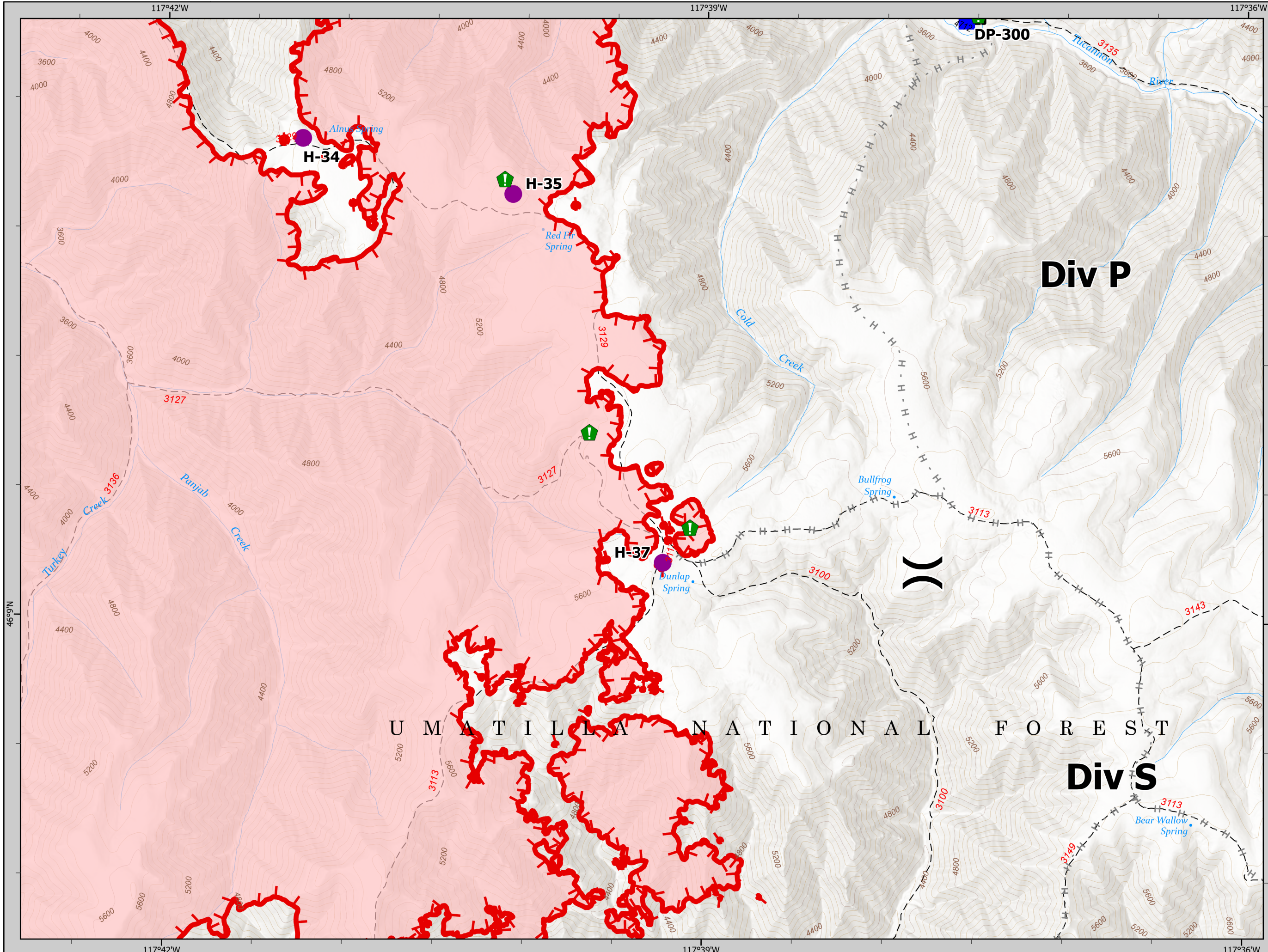





0 1,000 2,000 4,000 Feet



IAP
Green Ridge
OR-UMF-000659

8/3/21



-  Mobile Retardant Base
-  Helispot
-  Drop Point
-  Staging Area
-  Value at Risk
-  Repeater
-  Water Source
-  Planned Dozer Line

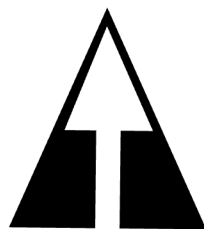
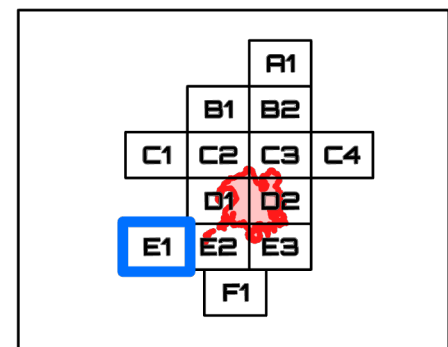

1:25,000 NAD83 UTM 11N

0 1,000 2,000 4,000 Feet

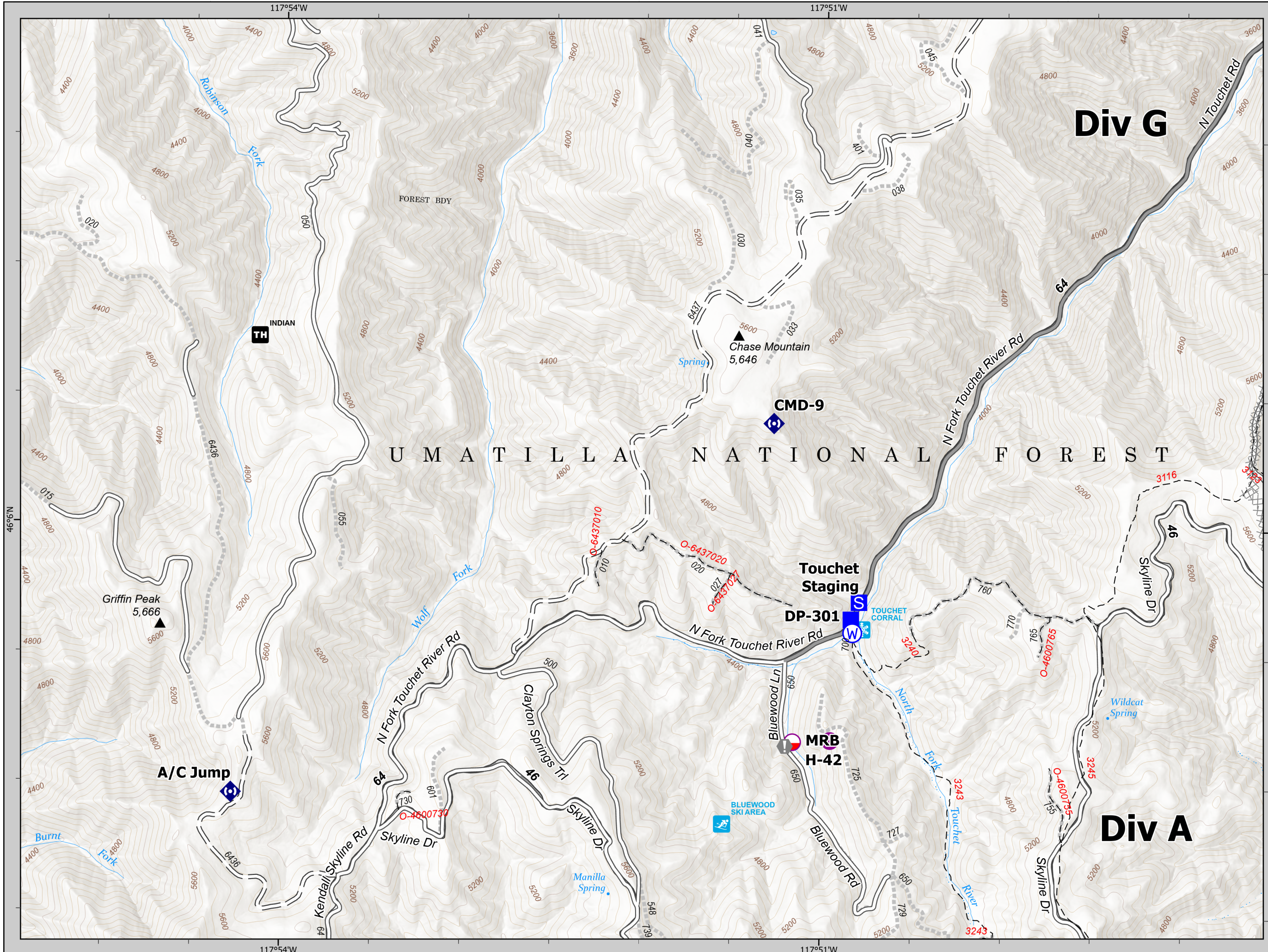

IAP
Green Ridge
OR-UMF-000659

8/3/21



- Helispot
- Division Break
- Drop Point
- S Staging Area
- Other
- Structure Wrap
- Repair Point
- Landing or Log Deck
- Dozer Push
- W Mobile Weather Unit
- R Repeater
- W Water Source
- Completed Dozer Line
- Completed Fuel Break
- Completed Hand Line
- Completed Mixed Construction Line
- Completed Road as Line
- Planned Dozer Line
- Planned Hand Line
- Highlighted Feature
- Other
- Fire Edge
- Wildfire Daily Fire Perimeter

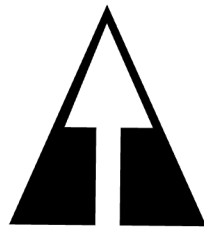
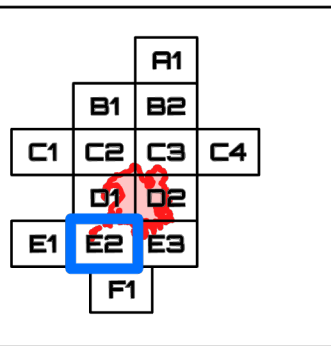

1:25,000 NAD83 UTM 11N

0 1,000 2,000 4,000 Feet

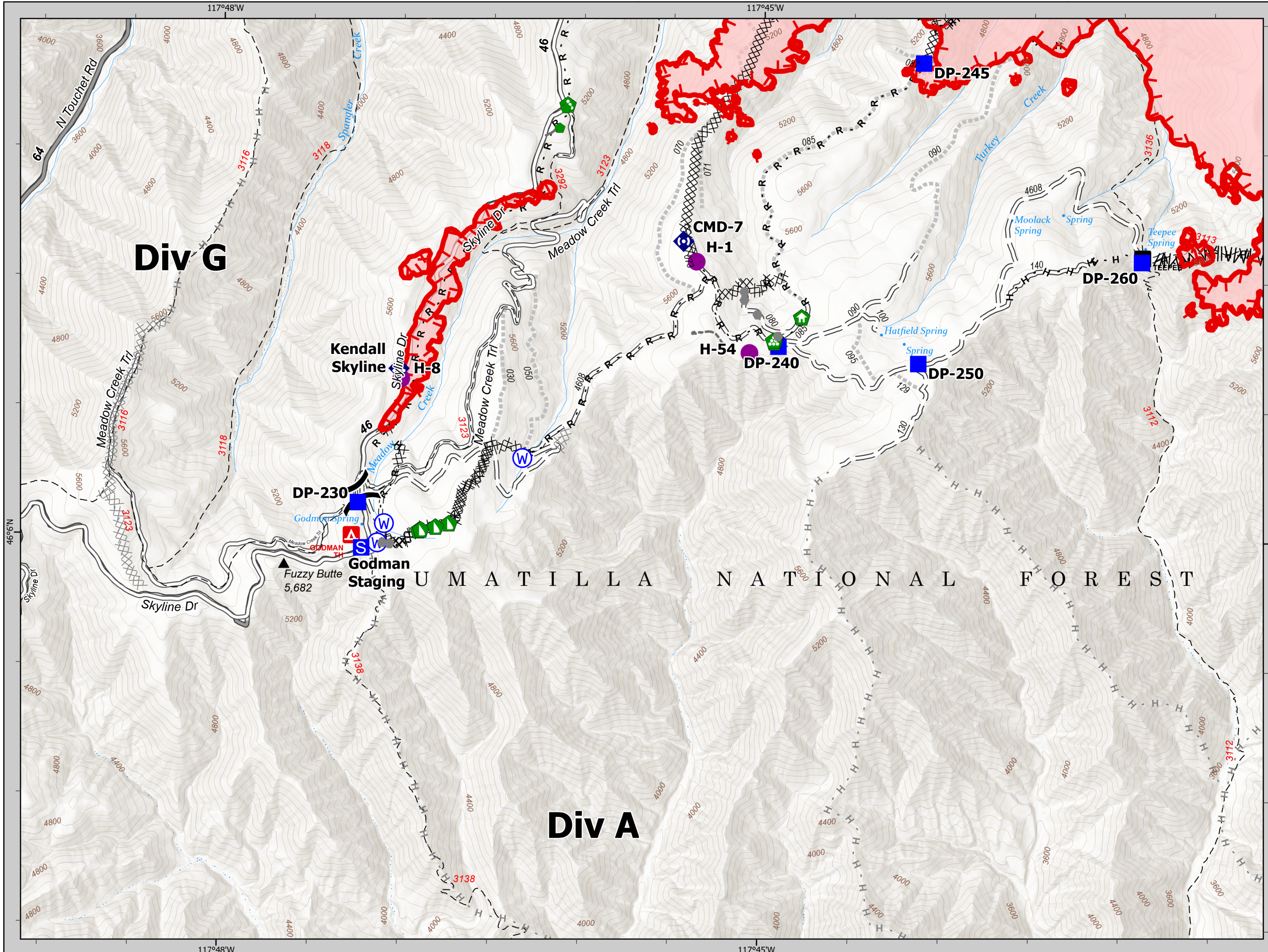

IAP
Green Ridge
OR-UMF-000659

8/3/21



- Helispot
- Division Break
- Drop Point
- ▲ Resource Location
- Completed Fuel Break
- Completed Hand Line
- Planned Fuel Break
- Planned Hand Line
- Fire Edge
- Wildfire Daily Fire Perimeter

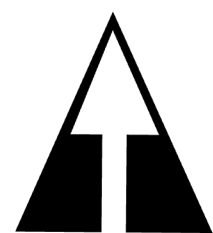
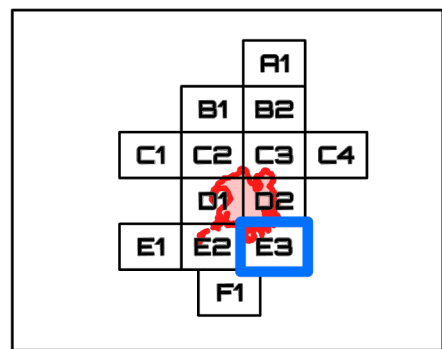
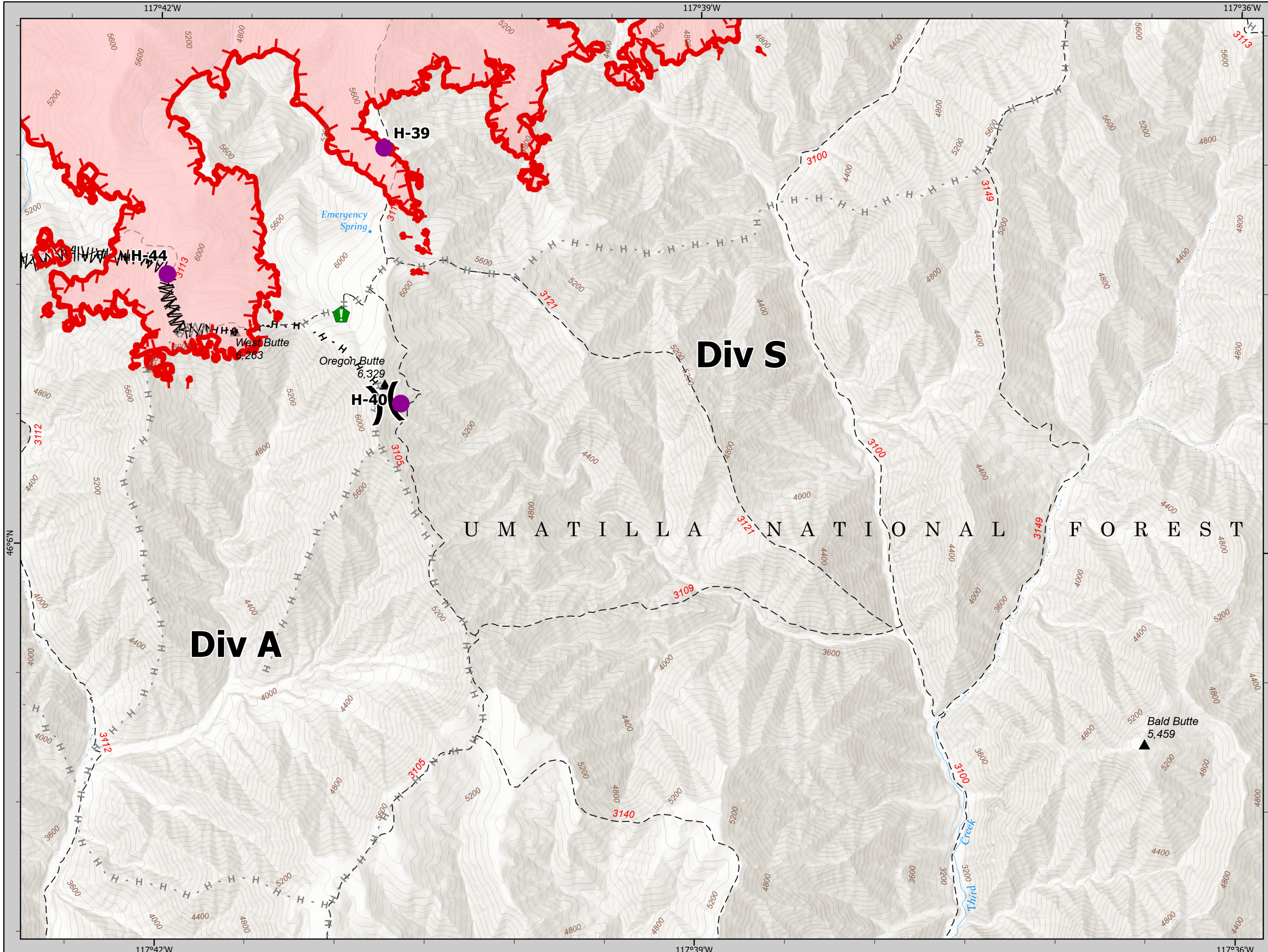

1:25,000 NAD83 UTM 11N

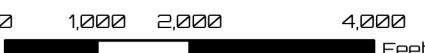

IAP
Green Ridge
OR-UMF-000659

8/3/21



H - Planned Hand Line

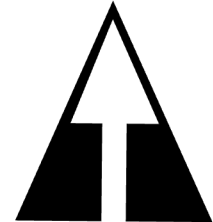
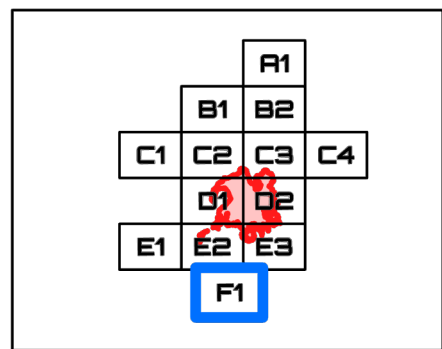

1:25,000 NAD83 UTM 11N

