

IAP  
Green Ridge  
OR-UMF-000659

8/7/21

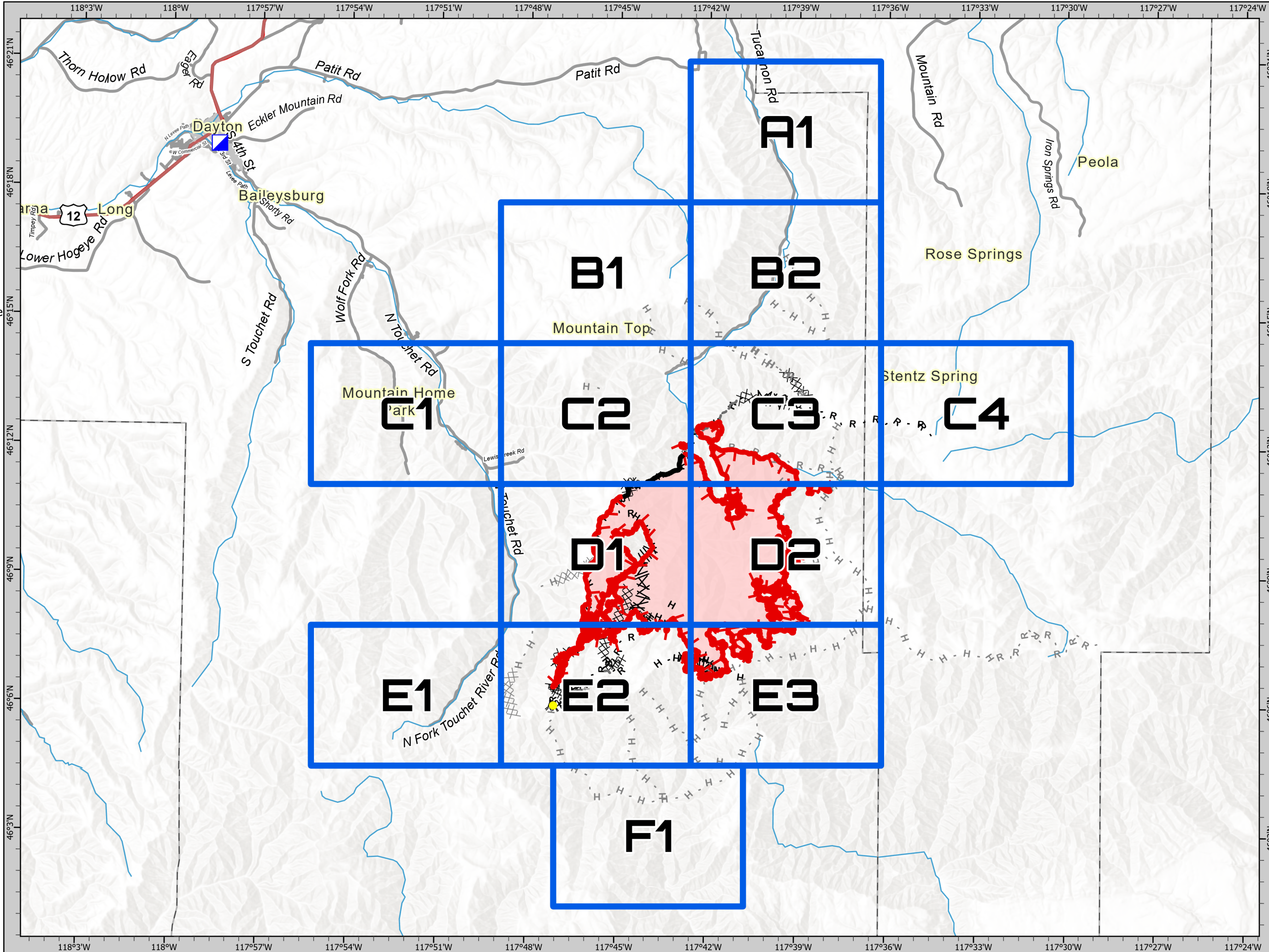

- Incident Command Post
- Completed Dozer Line
- Completed Fuel Break
- Completed Hand Line
- Completed Mixed Construction Line
- Completed Road as Line
- Planned Dozer Line
- Planned Fuel Break
- Planned Hand Line
- Planned Road as Line
- Highlighted Feature
- Other
- Repair Line
- Fire Edge
- Contained Line
- Wildfire Daily Fire Perimeter



IAP  
Green Ridge  
OR-UMF-000659

8/7/21



- Camp
- Repeater

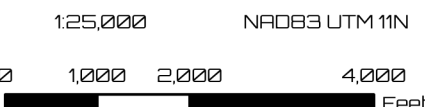
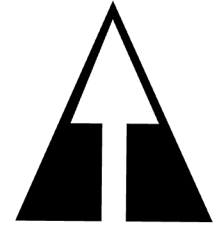
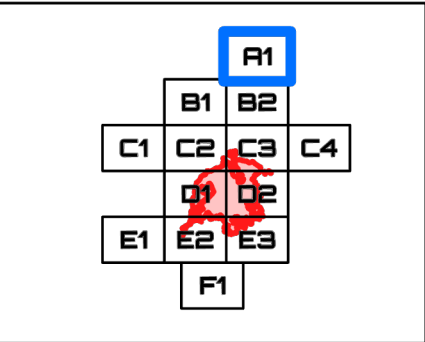
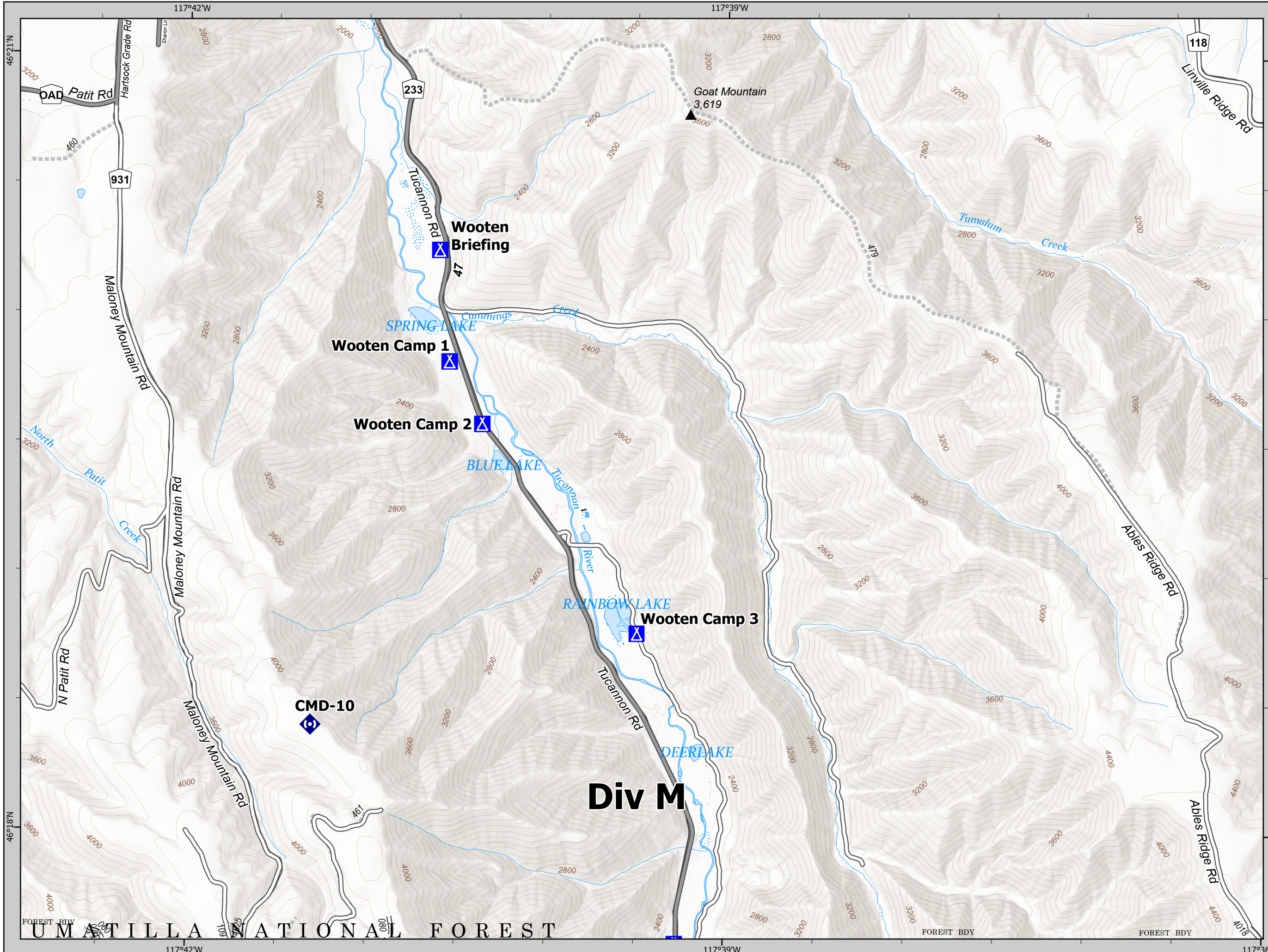

UMATILLA NATIONAL FOREST

IAP  
Green Ridge  
OR-UMF-000659

8/7/21



H - Planned Hand Line

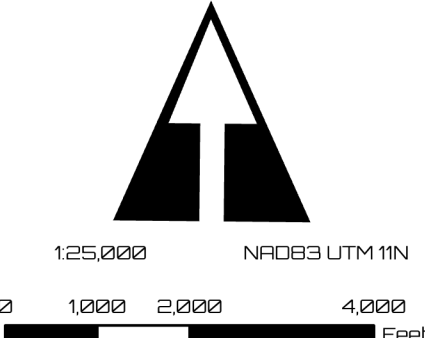
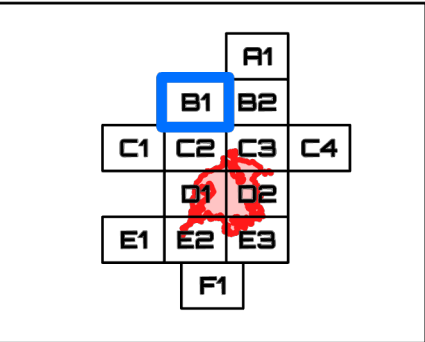
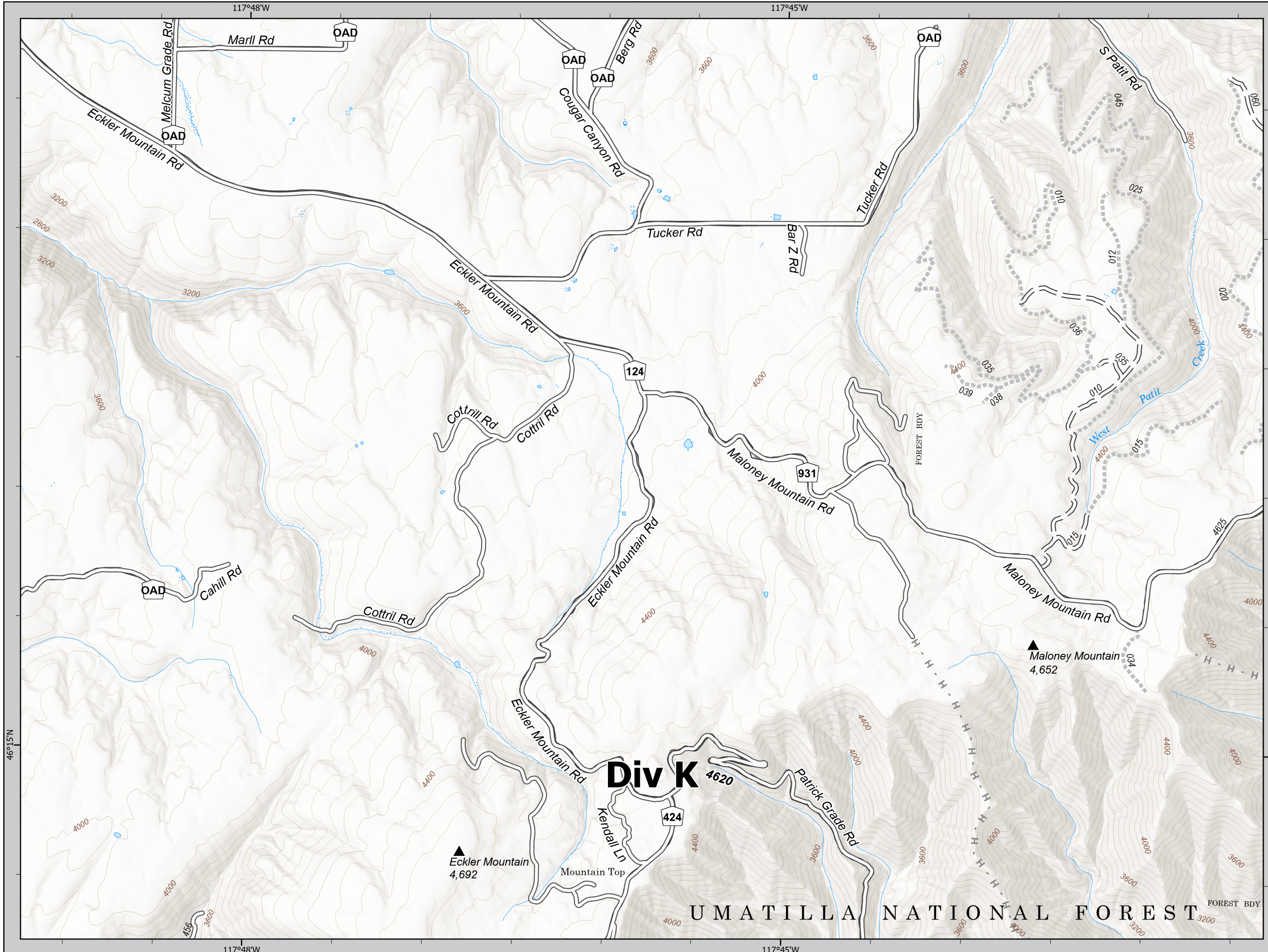

IAP  
Green Ridge  
OR-UMF-000659

8/7/21



- Drop Point
- ⊗ Camp
- ⊙ Water Source
- H - Planned Hand Line

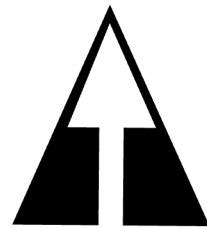
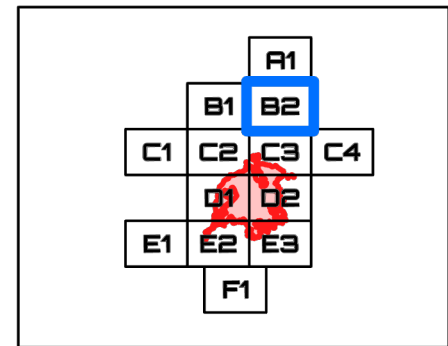



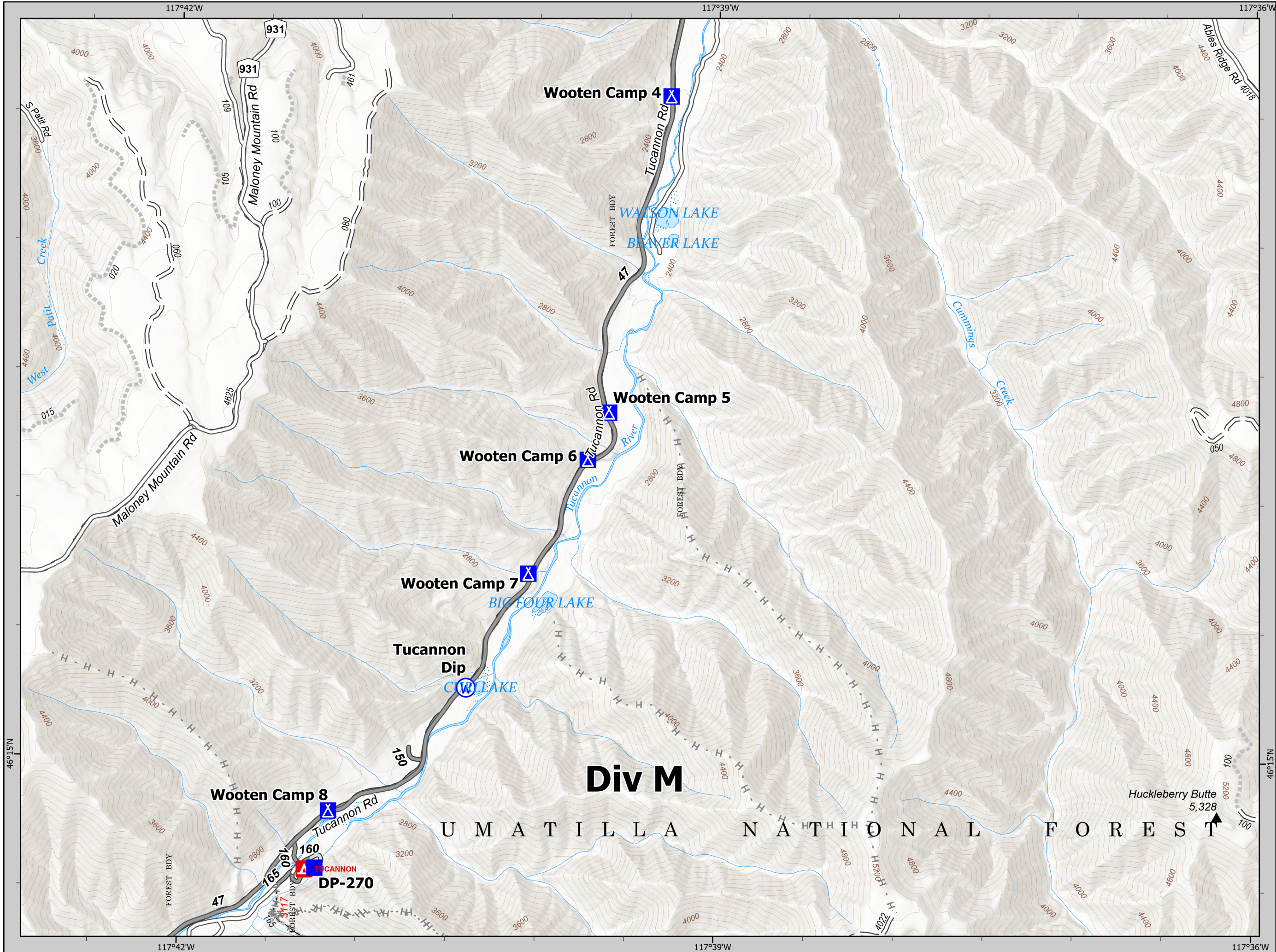
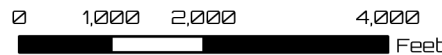

1:25,000 NAD83 UTM 11N



IAP  
Green Ridge  
OR-UMF-000659

8/7/21



-  Dip Site
-  Value at Risk
-  Gate
-  Bridge

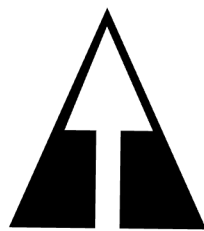
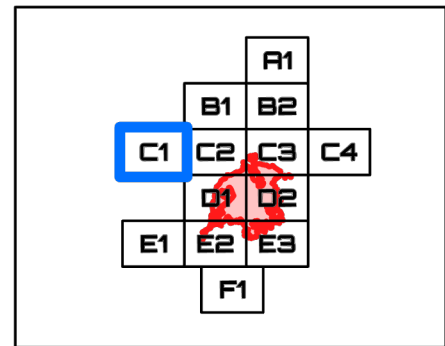

1:25,000 NAD83 UTM 11N

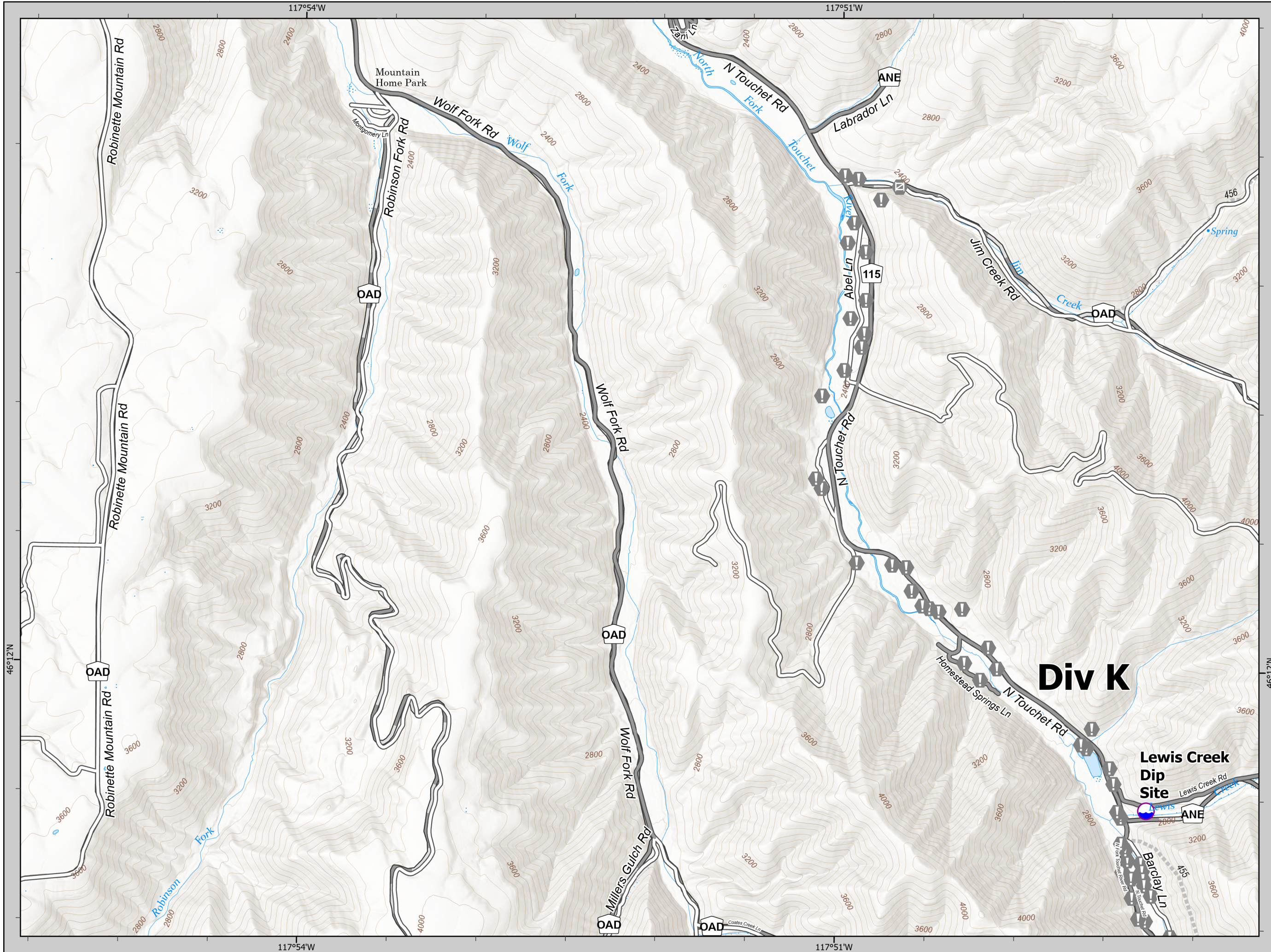
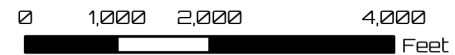

**Div K**

**Lewis Creek Dip Site**

IAP  
Green Ridge  
OR-UMF-000659

8/7/21



- Dip Site
- Helispot
- Sling Site
- Division Break
- Drop Point
- Camp
- Value at Risk
- Stream Crossing
- Repair Point
- Mobile Weather Unit
- Repeater
- Completed Dozer Line
- Completed Hand Line
- Completed Road as Line
- Planned Hand Line
- Planned Road as Line
- Other
- Fire Edge
- Contained Line
- Wildfire Daily Fire Perimeter

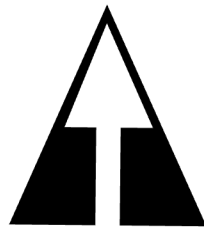
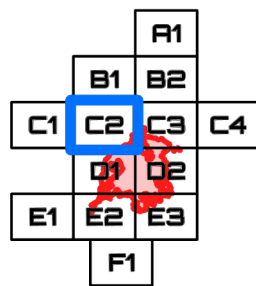

1:25,000 NAD83 UTM 11N

0 1,000 2,000 4,000 Feet

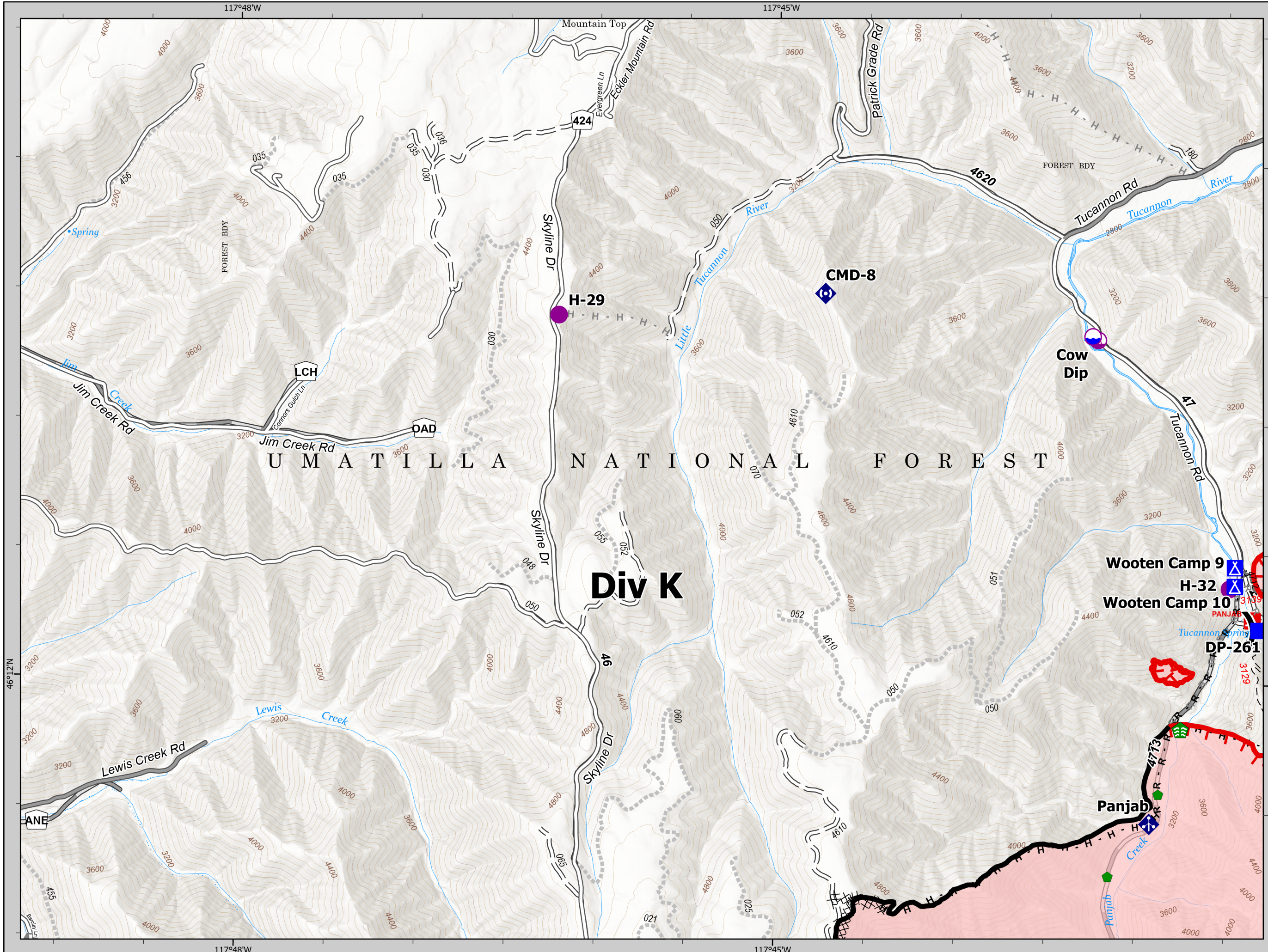

IAP  
Green Ridge  
OR-UMF-000659

8/7/21



- Helispot
- Sling Site
- ) Division Break
- Drop Point
- ▲ Camp
- Value at Risk
- Other
- Stream Crossing
- ▲ Road Repair
- Resource Location
- Repair Point
- Landing or Log Deck
- Dozer Push
- Mobile Weather Unit
- X Completed Dozer Line
- M Completed Fuel Break
- H Completed Hand Line
- R Completed Road as Line
- H Planned Hand Line
- R Planned Road as Line
- Other
- Repair Line
- Fire Edge
- Contained Line
- Wildfire Daily Fire Perimeter

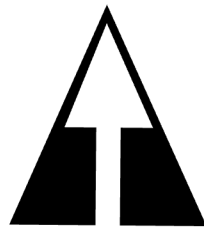
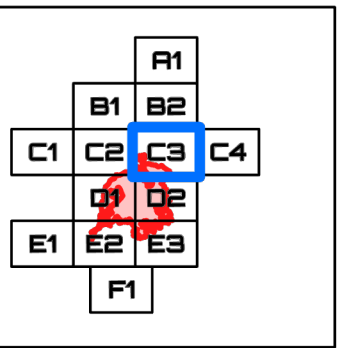

1:25,000 NAD83 UTM 11N

0 1,000 2,000 4,000 Feet

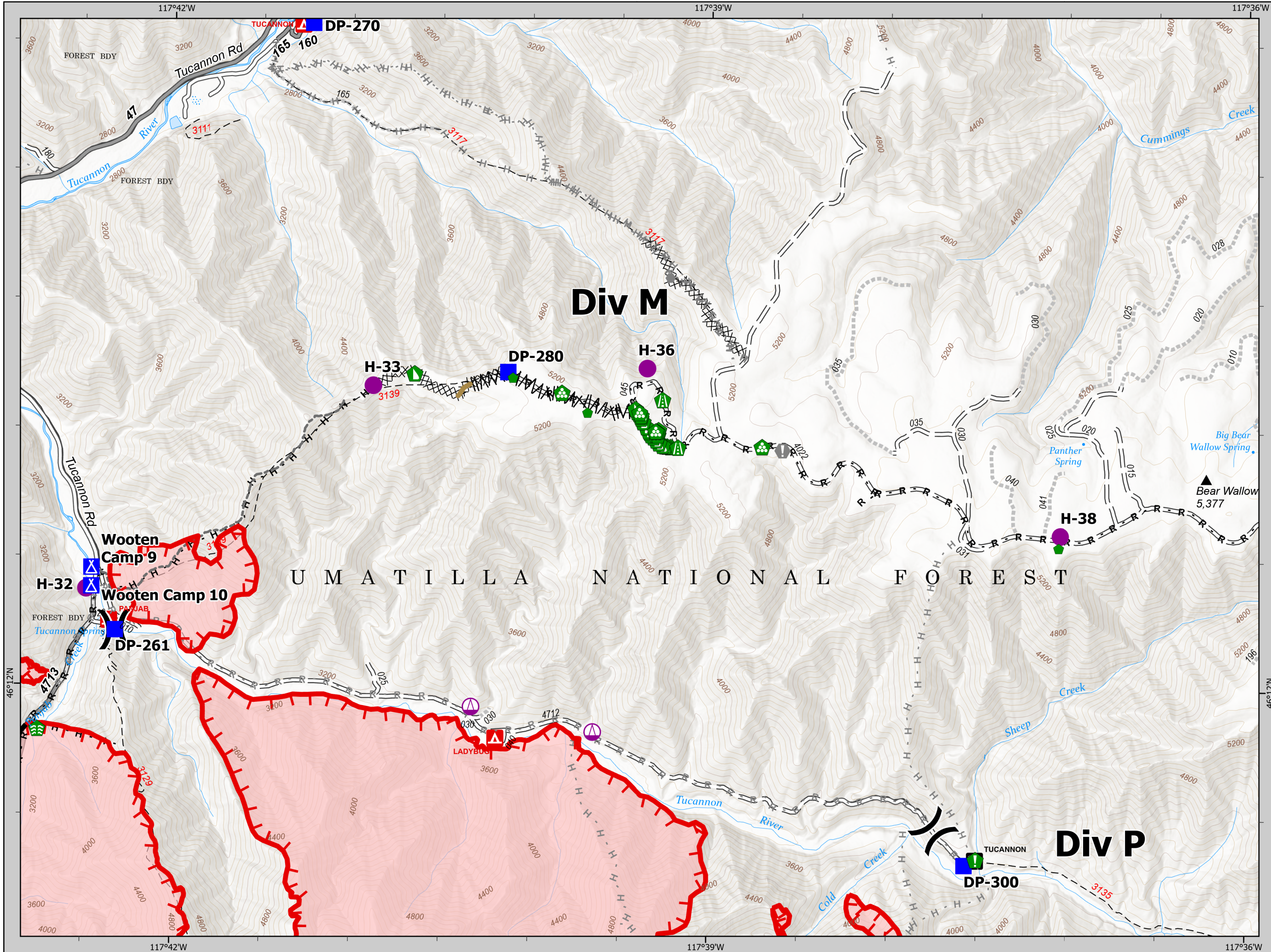

IAP  
Green Ridge  
OR-UMF-000659

8/7/21



- Helispot
- Drop Point
- Stream Crossing
- Repair Point
- R - Completed Road as Line

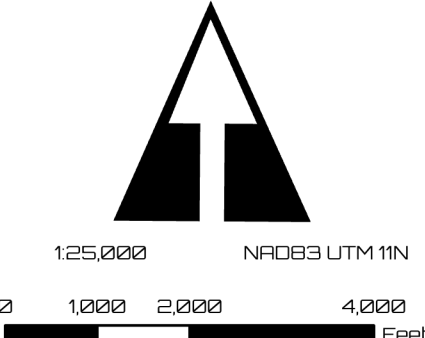
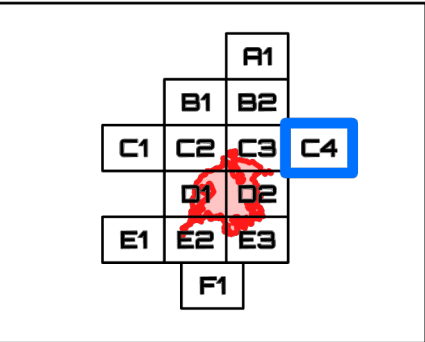
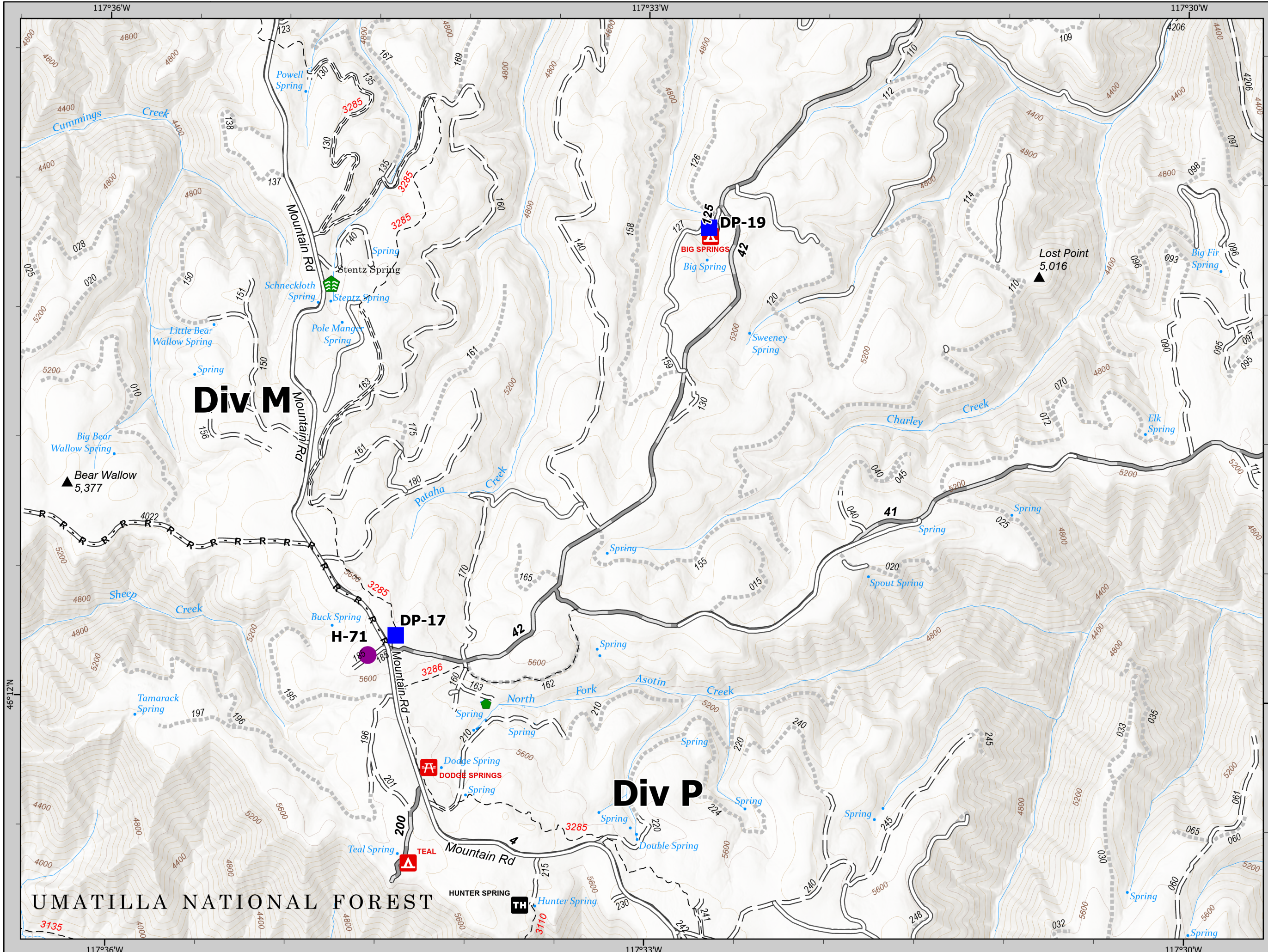



8/7/21



- Helispot
- Sling Site
- Division Break
- Drop Point
- Camp
- Lookout
- Value at Risk
- Resource Location
- Repair Point
- Landing or Log Deck
- Water Source
- Completed Dozer Line
- Completed Fuel Break
- Completed Hand Line
- Completed Road as Line
- Planned Dozer Line
- Planned Hand Line
- Fire Edge
- Contained Line
- Wildfire Daily Fire Perimeter

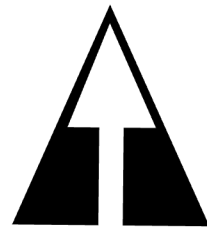
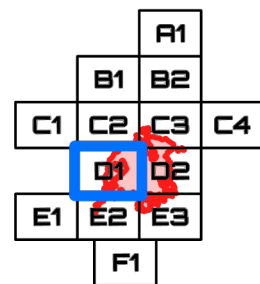

1:25,000 NAD83 UTM 11N

0 1,000 2,000 4,000 Feet

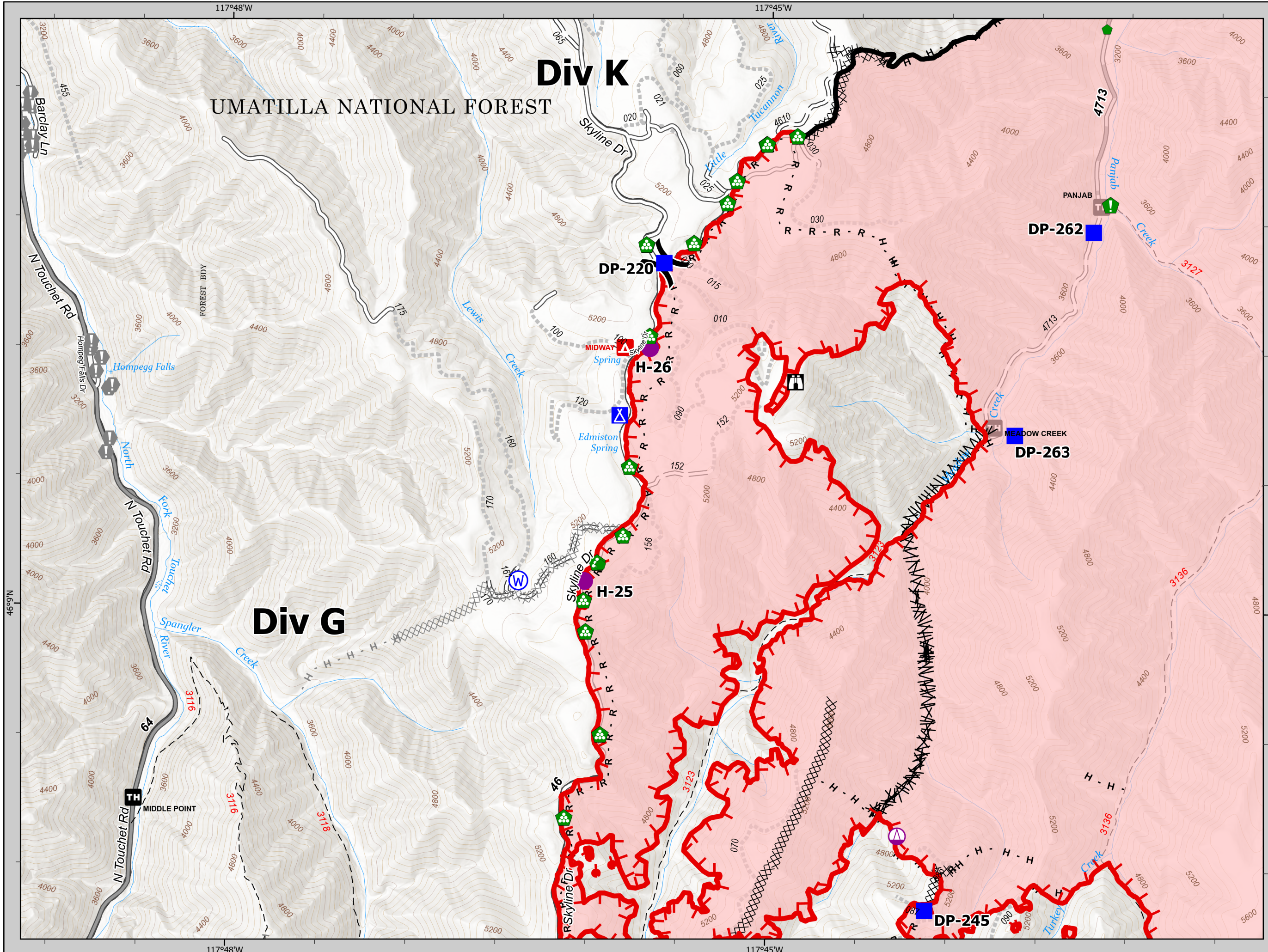

IAP  
Green Ridge  
OR-UMF-000659

8/7/21



- Helispot
- ) Division Break
- Drop Point
- Resource Location
- H - Planned Hand Line
- R - Planned Road as Line
- Fire Edge
- Wildfire Daily Fire Perimeter

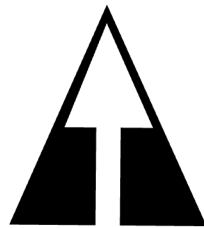
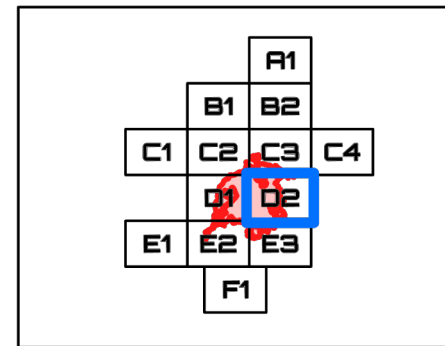

1:25,000 NAD83 UTM 11N



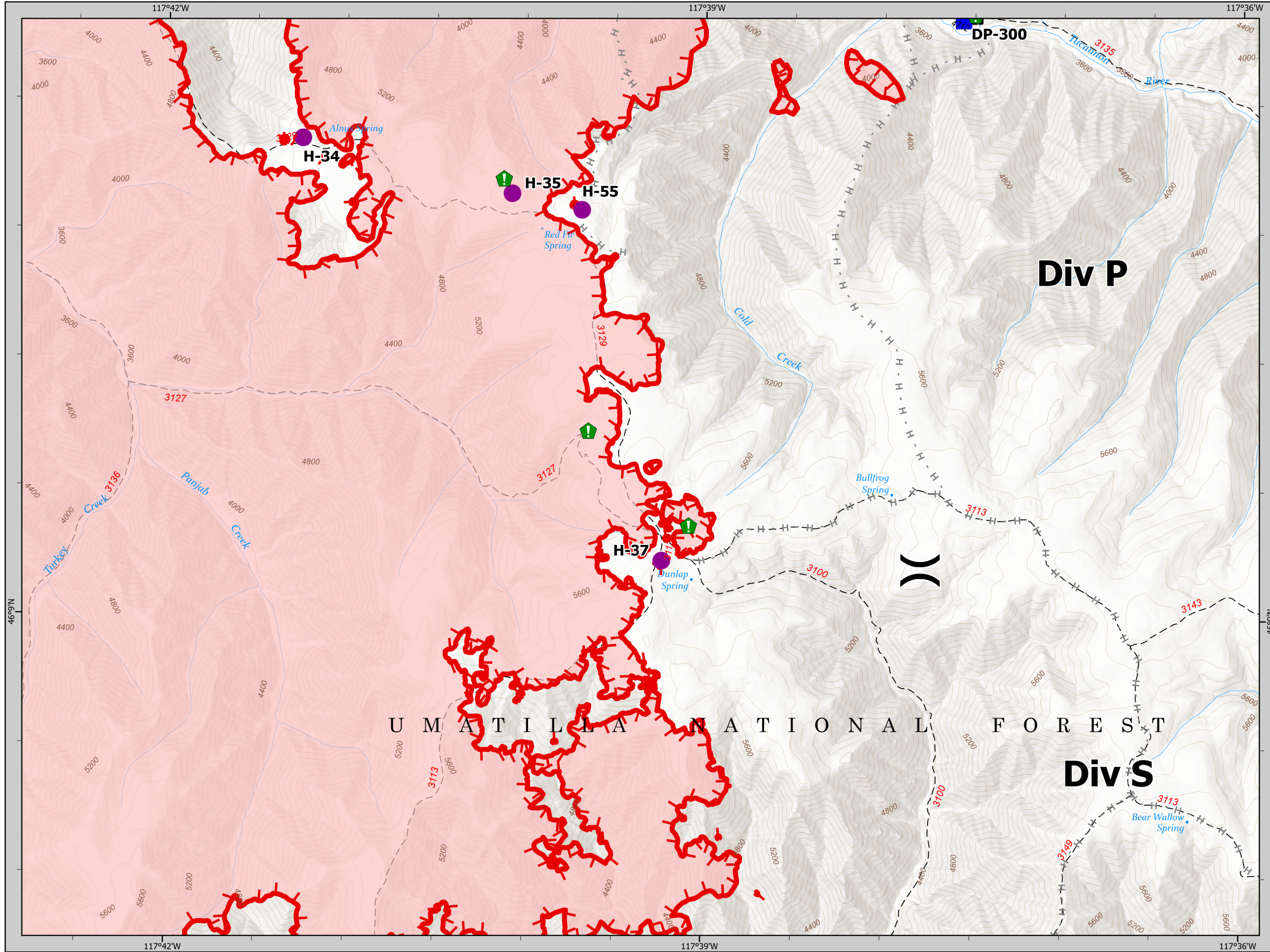





0 1,000 2,000 4,000 Feet



IAP  
Green Ridge  
OR-UMF-000659

8/7/21



-  Mobile Retardant Base
-  Helispot
-  Drop Point
-  Staging Area
-  Value at Risk
-  Repeater
-  Water Source
-  Planned Dozer Line

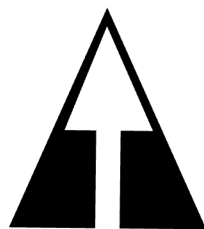
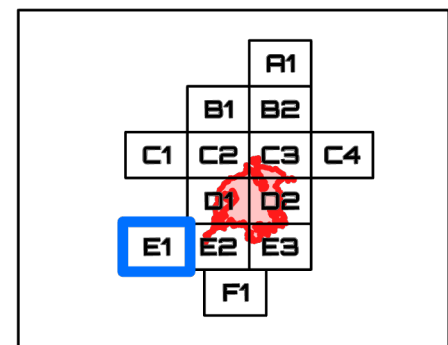

1:25,000 NAD83 UTM 11N

0 1,000 2,000 4,000 Feet

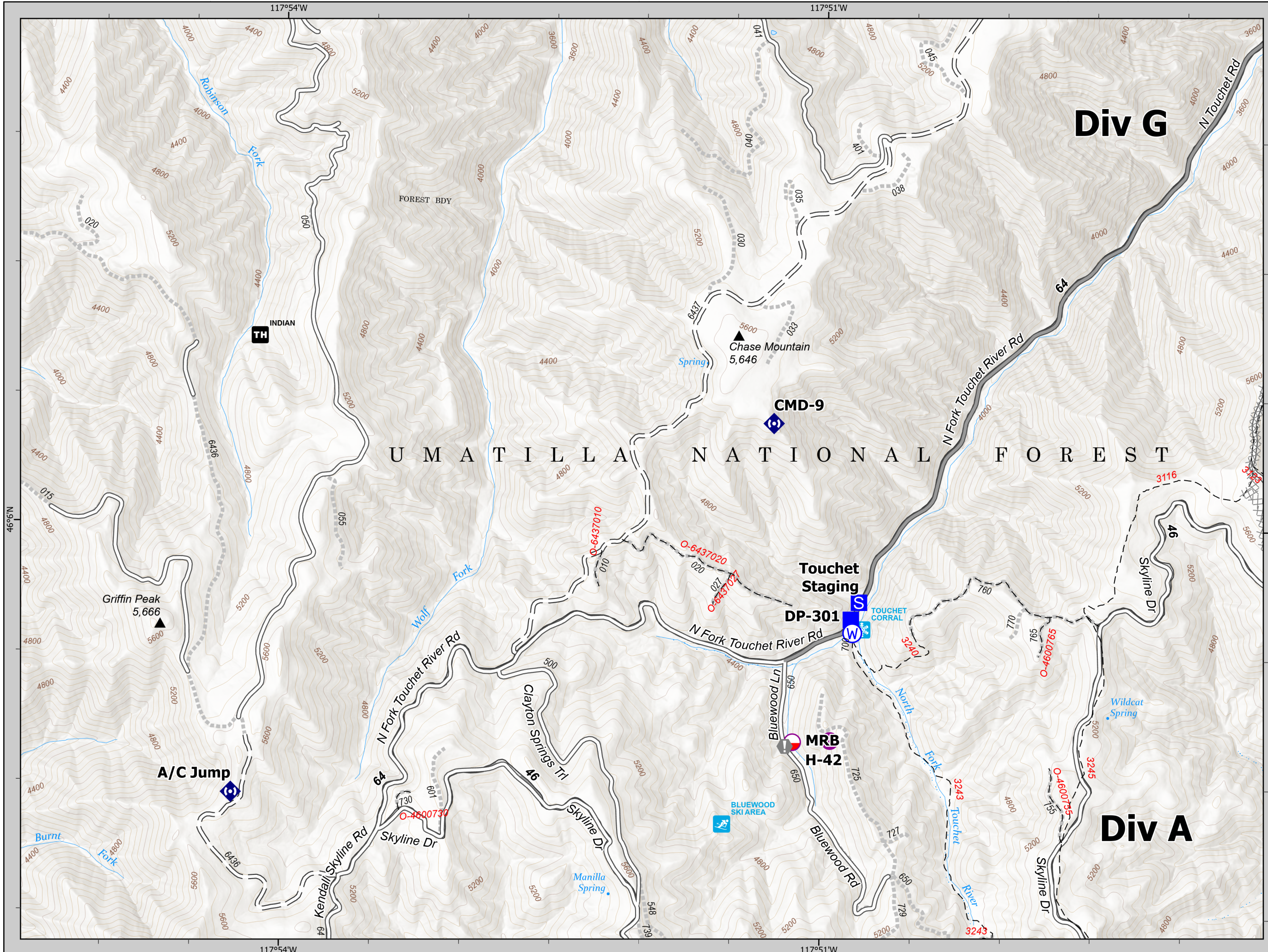

IAP  
Green Ridge  
OR-UMF-000659

8/7/21



- Helispot
- Division Break
- DP Drop Point
- S Staging Area
- Other
- G Gate
- S Structure Wrap
- R Repair Point
- L Landing or Log Deck
- D Dozer Push
- M Mobile Weather Unit
- R Repeater
- W Water Source
- Completed Dozer Line
- Completed Fuel Break
- Completed Hand Line
- Completed Mixed Construction Line
- Completed Road as Line
- Planned Dozer Line
- Planned Hand Line
- Highlighted Feature
- Other
- Fire Edge
- Wildfire Daily Fire Perimeter

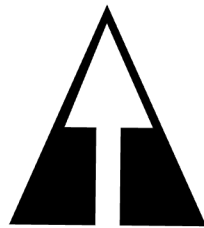
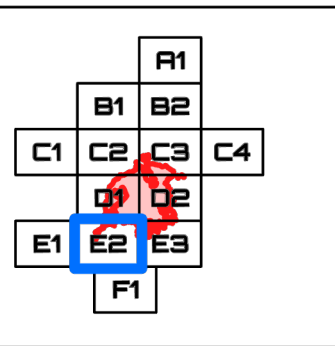

1:25,000 NAD83 UTM 11N

0 1,000 2,000 4,000 Feet

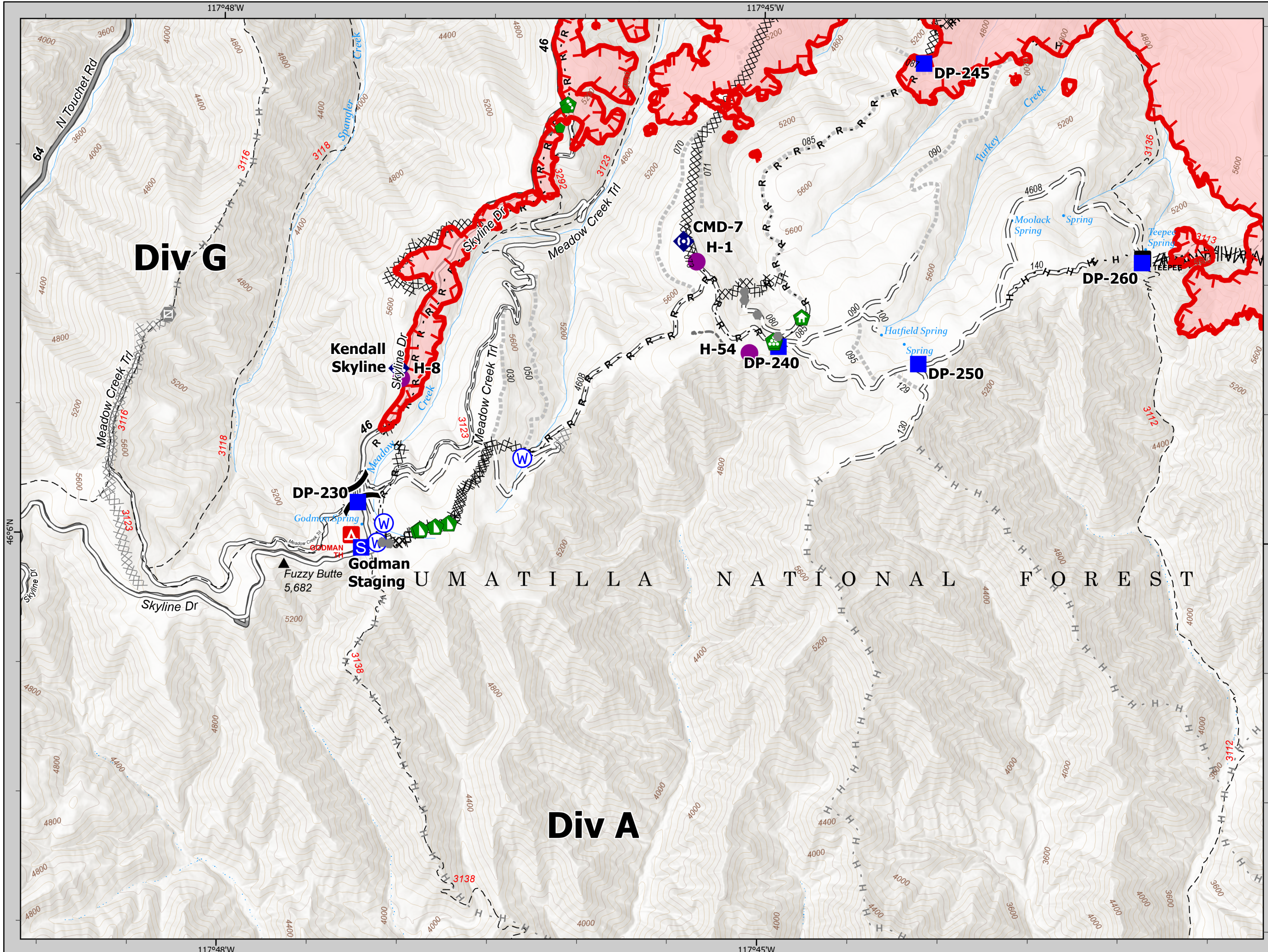

IAP  
Green Ridge  
OR-UMF-000659

8/7/21



- Helispot
- ) Division Break
- Drop Point
- Resource Location
- Completed Fuel Break
- - Completed Hand Line
- - Planned Fuel Break
- - Planned Hand Line
- ▭ Fire Edge
- ▭ Wildfire Daily Fire Perimeter

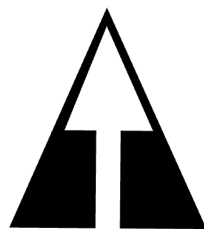
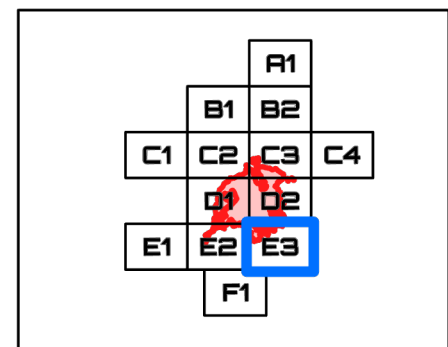

1:25,000 NAD83 UTM 11N

0 1,000 2,000 4,000 Feet

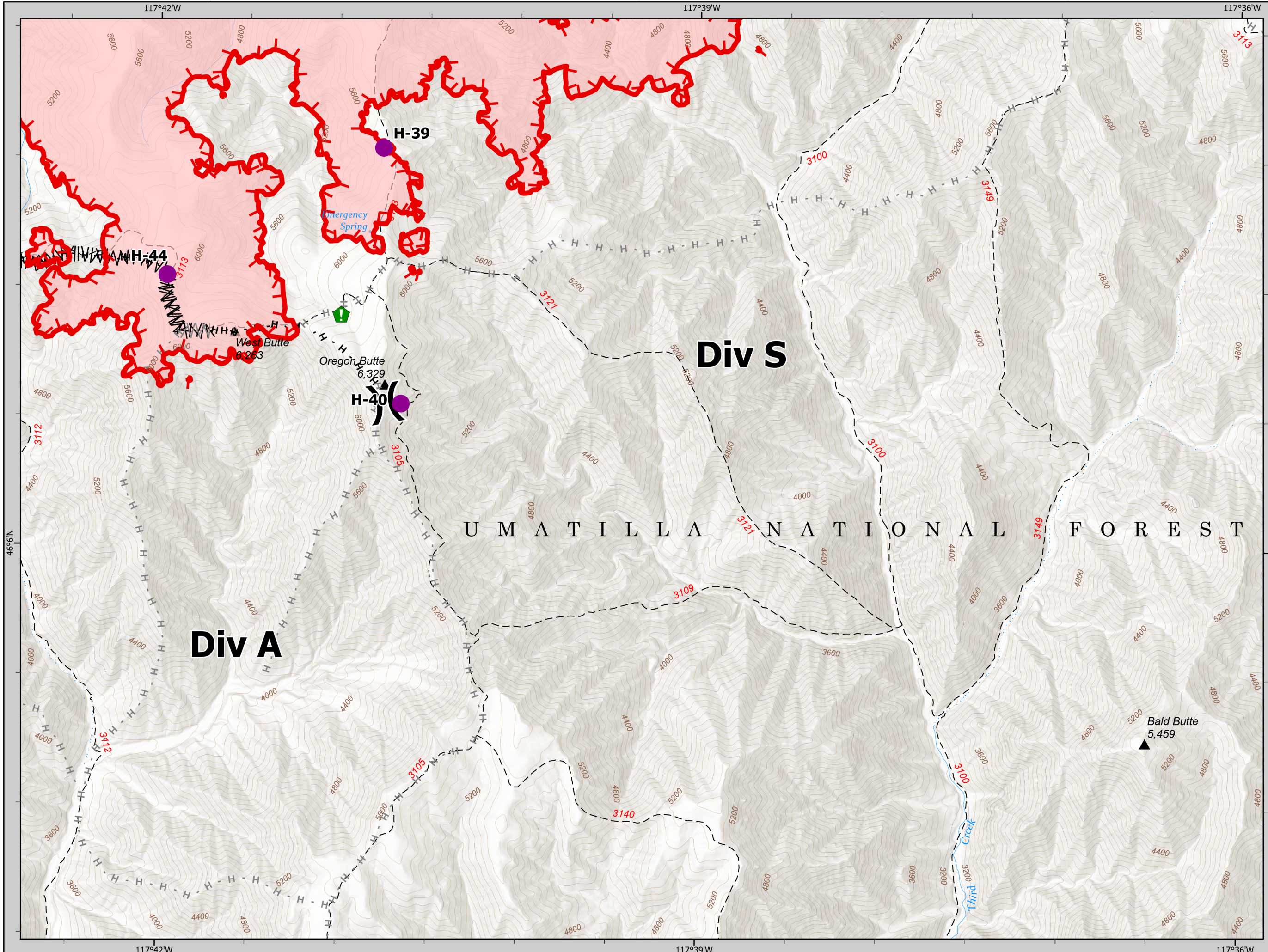

IAP  
Green Ridge  
OR-UMF-000659

8/7/21



H - Planned Hand Line

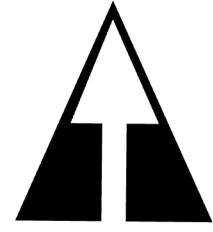
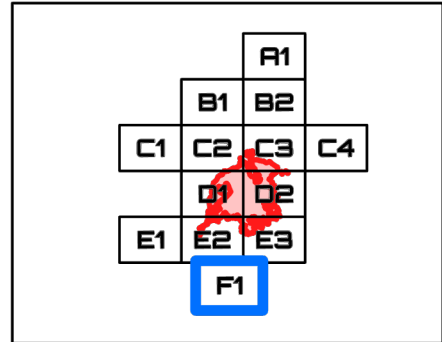

1:25,000 NAD83 UTM 11N

