

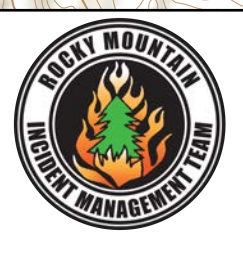

















Div F
Pine Gulch
 COGRD-000307
 08/17/2020 Day

Appx 84,161 acres
 @2120 08/16/2020

-  Camp
-  Drop Point
-  Value at Risk
-  Division Break
-  Branch Break
-  Abandoned Well
-  Active Well
-  Shut-in Well
-  Uncontrolled Fire Edge
-  Proposed Dozer Line
-  Power Transmission Lines
-  Highway or ramp
-  Local or 4WD road
-  Bureau of Land Management
-  Private

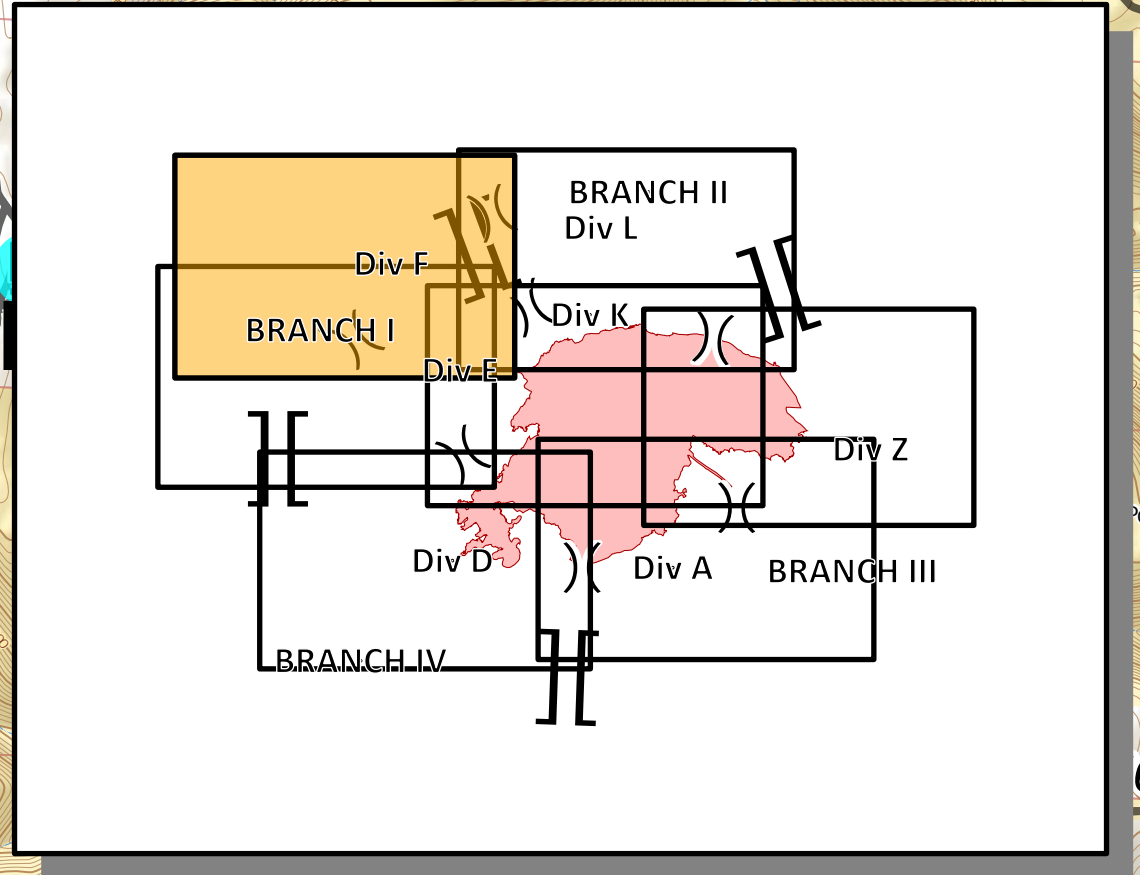
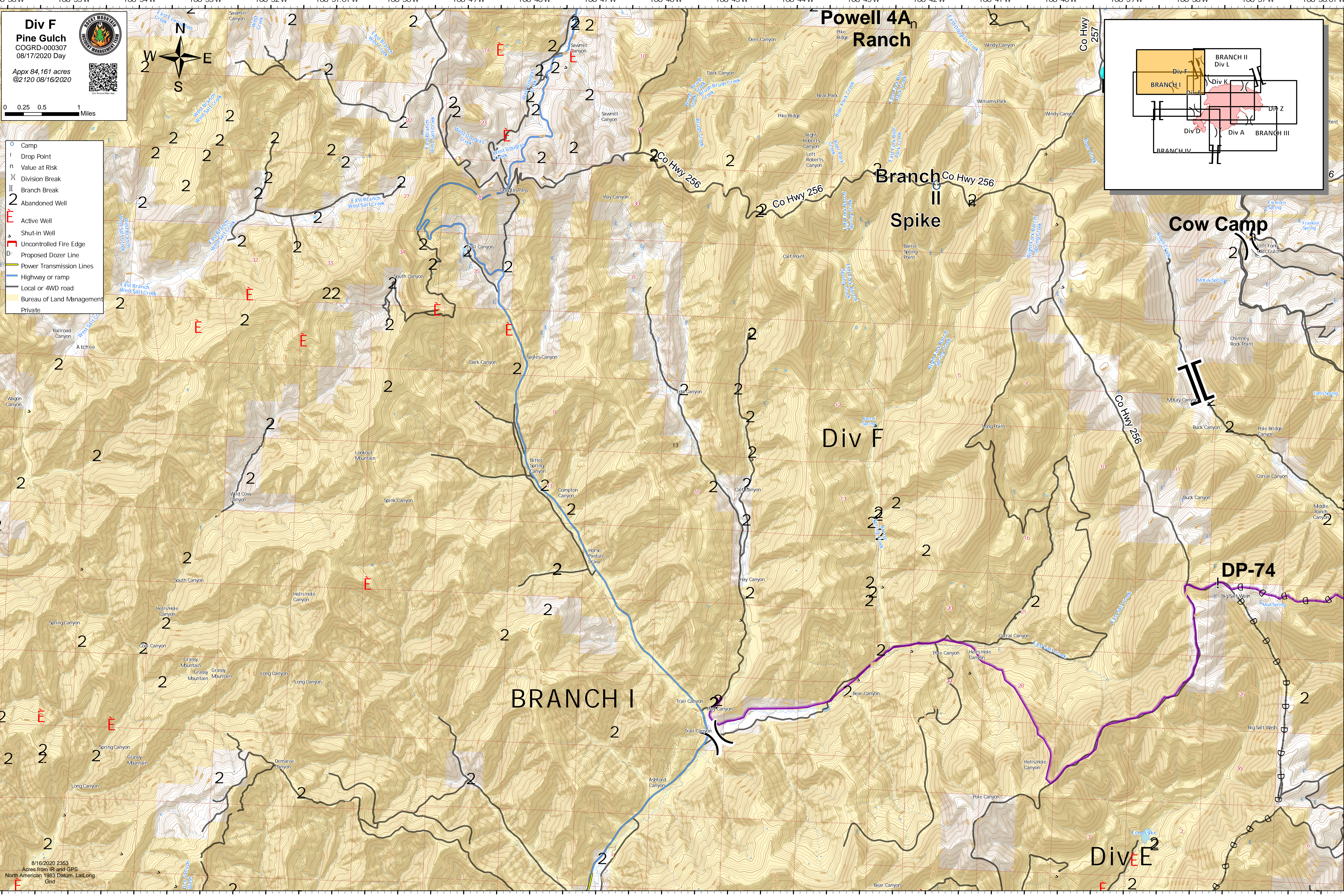

8/16/2020 2353
 Acres from IR and GPS
 North American 1983 Datum, Lat/Long
 Grid